



BIM FOR YOUR PROJECT BUILDING INFORMATION MODELING WITH SIKA

BUILDING TRUST





THE DAWN OF DIGITAL CONSTRUCTION

The future of digital is now. The world is moving faster each day, and the construction industry is in dire need of optimization methods to keep up to speed. Digital workflows may be the best solution to help expedite the construction process, improve collaboration, and decrease overall costs. Where traditional pen, paper and two-dimensional drafting tools were standard practice, data-intensive three-dimensional computerized software and new interactive workflows are now being used to design and build the most complex constructions. The global construction industry is increasingly adopting Building Information Modeling (BIM) to facilitate the new process, thus realizing great benefits. Some regions are adopting BIM at an intensive rate due to regional requirements and local government mandates, while others are awaiting proof of advantages. While BIM acceptance worldwide steadily grows, one sentiment is shared – BIM is here to stay.

W Barcelona Hotel – Spain
Architect: Ricardo Bofill
BIM: N/A

The facade is bonded with Sikasil® and SikaGlaze® sealants

CONTENTS

04 What is BIM?

06 What are the Benefits of BIM?

08 Who We are at Sika

10 Added Value Sika Brings to Your BIM Project

12 Sika Flooring BIM Objects

14 Sika Roofing BIM Objects

16 Sika Waterproofing BIM Objects

20 BIM Case Studies

WHAT IS BIM?

BUILDING INFORMATION MODELING is changing the construction industry. At its core, it is a collaborative way of working, supported by software tools that make information about buildings available and analyzable.*

All stakeholders are involved and work together on one 3D building model, which ensures coordinated planning with less failures and better managed interfaces. As an intelligent 3D model-based process, BIM equips architecture, engineering, and construction professionals with the insight and tools to more efficiently plan, design, construct, and manage buildings and infrastructure.

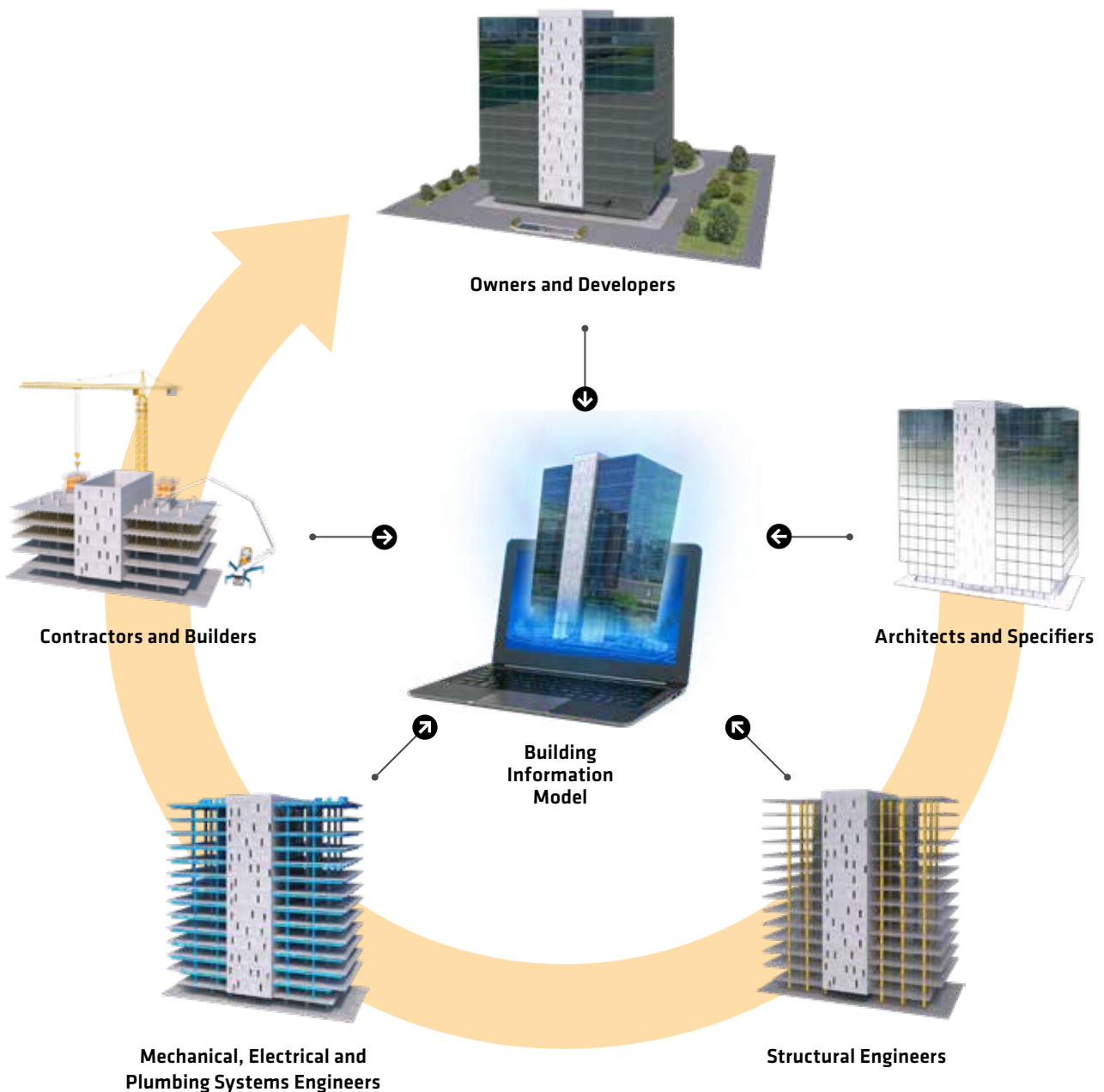

* Source: NBS International BIM Report 2016



Digital Tools

The tools behind BIM are digital and require trained professionals who understand the workflow and chosen software platform. With the right tools, BIM brings your entire project to your team's fingertips for faster coordination in the office and on the construction site, whether on a computer, tablet or smartphone device.



Thinking in a New Dimension

BIM adds a new dimension to the design process and requires a new way of thinking beyond traditional two-dimensional pen and paper methods. The entire project team will succeed when they embrace the third dimension and additional data, such as material properties, quantities, manufacturer-specific product details and more, which is embedded into the BIM workflow.

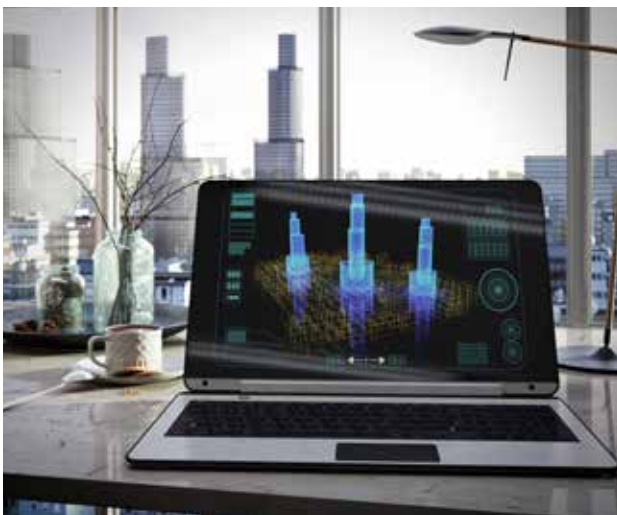

Global and Local Development

BIM is not a software, but a process to design, collaborate, simulate, check and control the design and building processes in a virtual environment. The activities around BIM are independently driven, since it doesn't belong to any company, association or country. BIM is developing on a global level, and also has some local, country specific factors.

WHAT ARE THE BENEFITS OF BIM?

WHEN BUILDING INFORMATION MODELING is used to its greatest potential, it can optimize the entire process of building, from early preliminary design through to construction and operations.

The MacLeamy curve shown below was developed by Patrick MacLeamy, chairman of HOK (global architectural design and services firm), to represent the advantages of replacing a traditional drafting-centric workflow with a BIM workflow. The investment during the detailed design phase in the BIM workflow allows for a greater ability to impact cost and performance, which results in a reduction of overall costs. By focusing efforts earlier on in the design phase, the BIM workflow can save a lot of time, effort and resources later on.

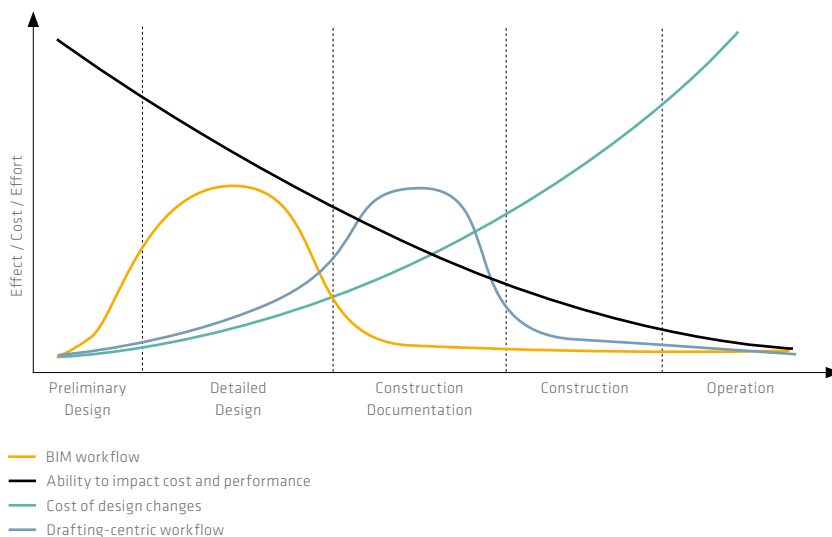

Benefits of working with BIM include the following:

- Simplified, early-stage clash detection
- Increase in productivity
- Time and cost savings
- Higher returns on investment (ROI)
- Gain competitive advantage
- Smoother handovers

Simplified Clash Detection

The project team can find discrepancies between various disciplines earlier in the project and avoid reworking later on when costs and time needed increase. For example, if a structural beam conflicts with a mechanical duct, it could be noticed within the BIM model and resolved prior to construction.

Increase in Productivity

Better collaboration, reduced errors, and fewer requests for information and confusion on the construction site are a few of the ways BIM brings about more productive workflows. The dynamic features of BIM software allow for faster design changes and embedded data in the model shared with the entire project team saves communication time.

Time and Cost Savings

Along with increased productivity, comes savings in labor and material costs on a project, from the design phase through to construction. Because design and construction are dynamically linked in the BIM workflow, time needed to execute design changes, and produce construction documentation is reduced significantly.





Blue Planet Aquarium - Denmark
Architect: 3XN
BIM: Tekla
All pools have a surface treatment with
Sikagard®-720 Epocem and Sikagard®-62.

Higher Returns on Investment (ROI)

According to the McGraw-Hill Construction report, over 80% of expert BIM users report positive returns. After initial investment and BIM workflow integration, most project teams notice reduced design change costs, less time needed to manage requests for information during construction and ultimately an optimized profit-earning potential.

Gain Competitive Advantage

BIM is becoming more commonly requested by clients, owners and governmental agencies. Therefore, to be able to offer superior services to your clients, you have to maintain a competitive edge. Your clients will be happy to hear how they too can save time and money by working with you.

Smoother Handovers

Detailed data about every aspect of the building is factored into the BIM model. Therefore, it is a true digital representation of the building, which can be provided to the building owner for easier long term operation, maintenance and repairs.

WHO WE ARE AT SIKA

WITH OVER 100 YEARS OF EXPERIENCE, Sika has knowledge you can trust.



As a leading global supplier of construction materials with subsidiaries in over 90 countries, Sika is your partner in BIM wherever you are. The core of Sika business is global technology leadership in innovation while focusing on developing quality products with the best solutions for you. We also offer on site support throughout the construction phase of your project. We understand the growing importance of BIM for your entire project team, and strive to meet all your project needs including special requirements for BIM.

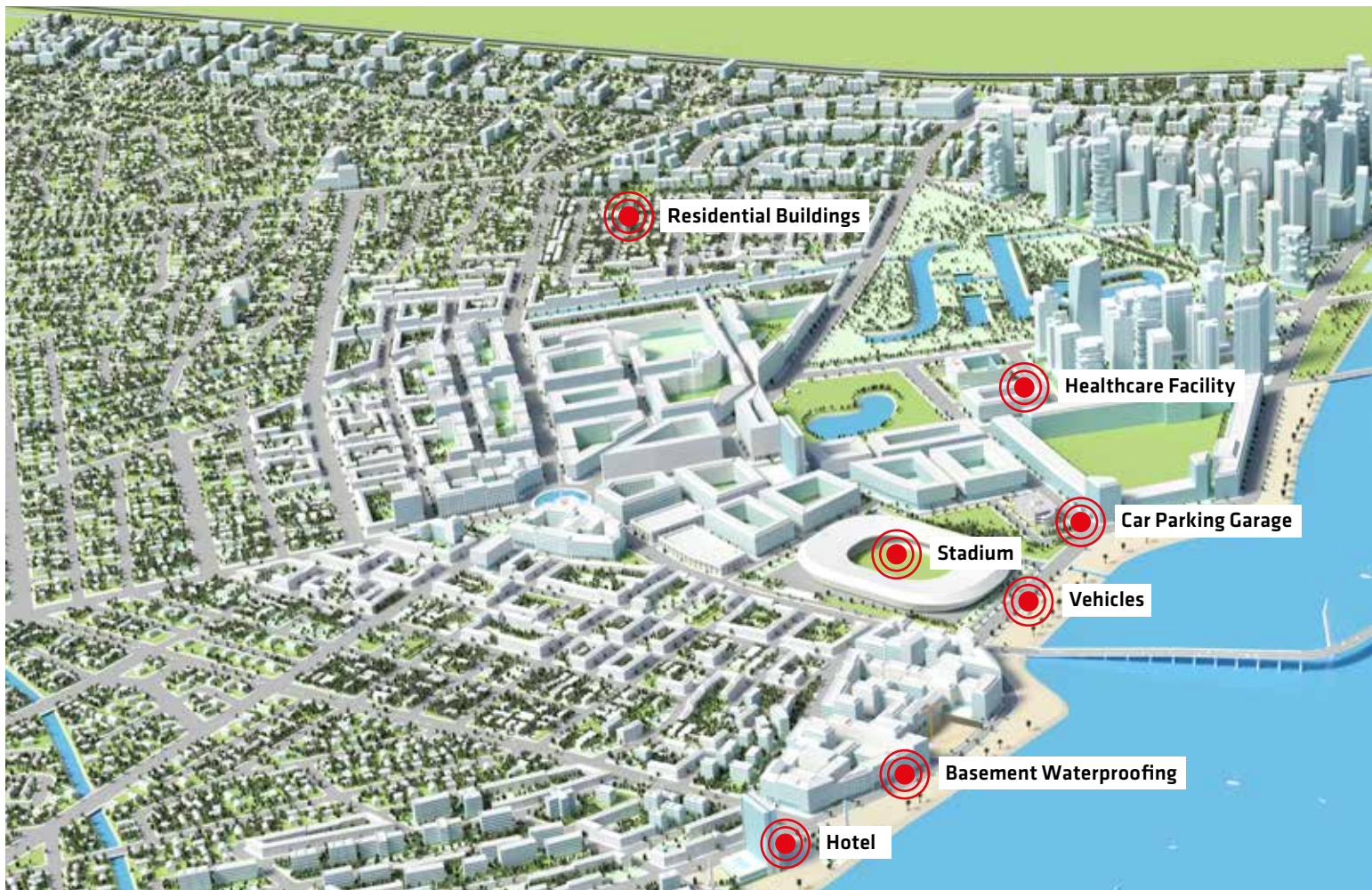

SIKA HAS BASEMENT-TO-ROOF SOLUTIONS for every project type.

We provide full range smart construction material systems for many types of construction projects, whether your project has specific needs for the interior or exterior, basement waterproofing, flooring, wall coatings, facades, roofing, concrete and so much more. Sika provides integrated, fully compatible products for projects worldwide such as:

- Residential buildings and hotels
- Healthcare centers and hospitals
- Sports facilities and stadiums
- Highrise
- Parking garages
- Airports
- Bridges
- Manufacturing facilities
- Educational buildings
- Science and research facilities
- Commercial spaces
- And many more



SikaSmart online selection guide
To navigate through the
interactive SikaSmart guide,
please scan the QR code or visit:
www.sika.com/sikasmart

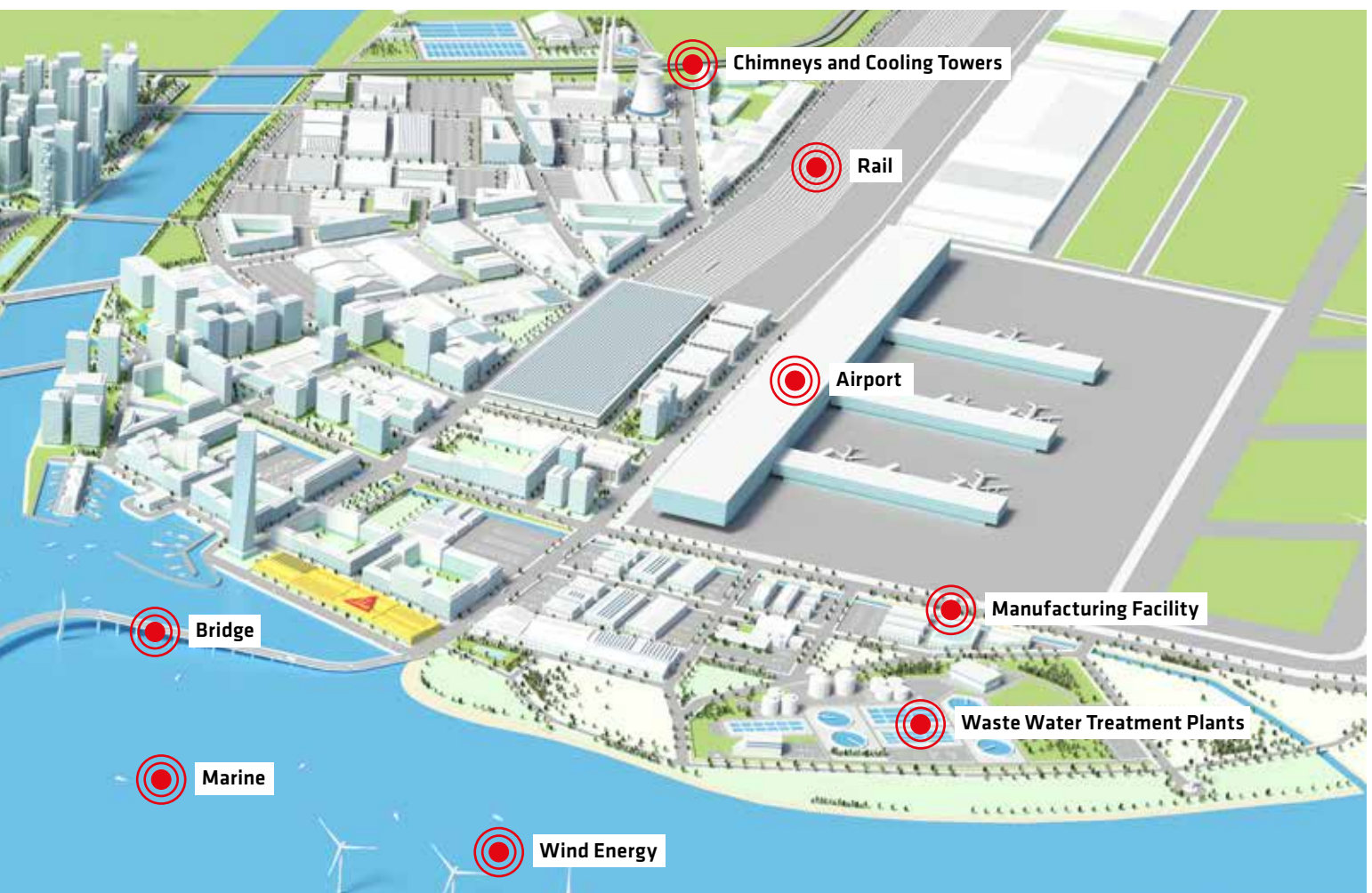

ADDED VALUE SIKA BRINGS TO YOUR BIM PROJECT

AS YOUR PARTNER IN BIM, we support the entire project team throughout the planning and construction process.



We understand that architects, designers and engineers spend a lot of time drawing and specifying, so we provide BIM objects which make it effortless to embed our product data into your BIM workflow. Sika has become one of the first in the field to create and provide BIM objects.

Also, as part of our standard Sika service, we offer on-site support throughout the construction phase and beyond. We know that BIM may be a new workflow for your project team, and we will stand by you to ensure your BIM project succeeds.

HOW SIKA SUPPORTS YOUR BIM PROJECTS:

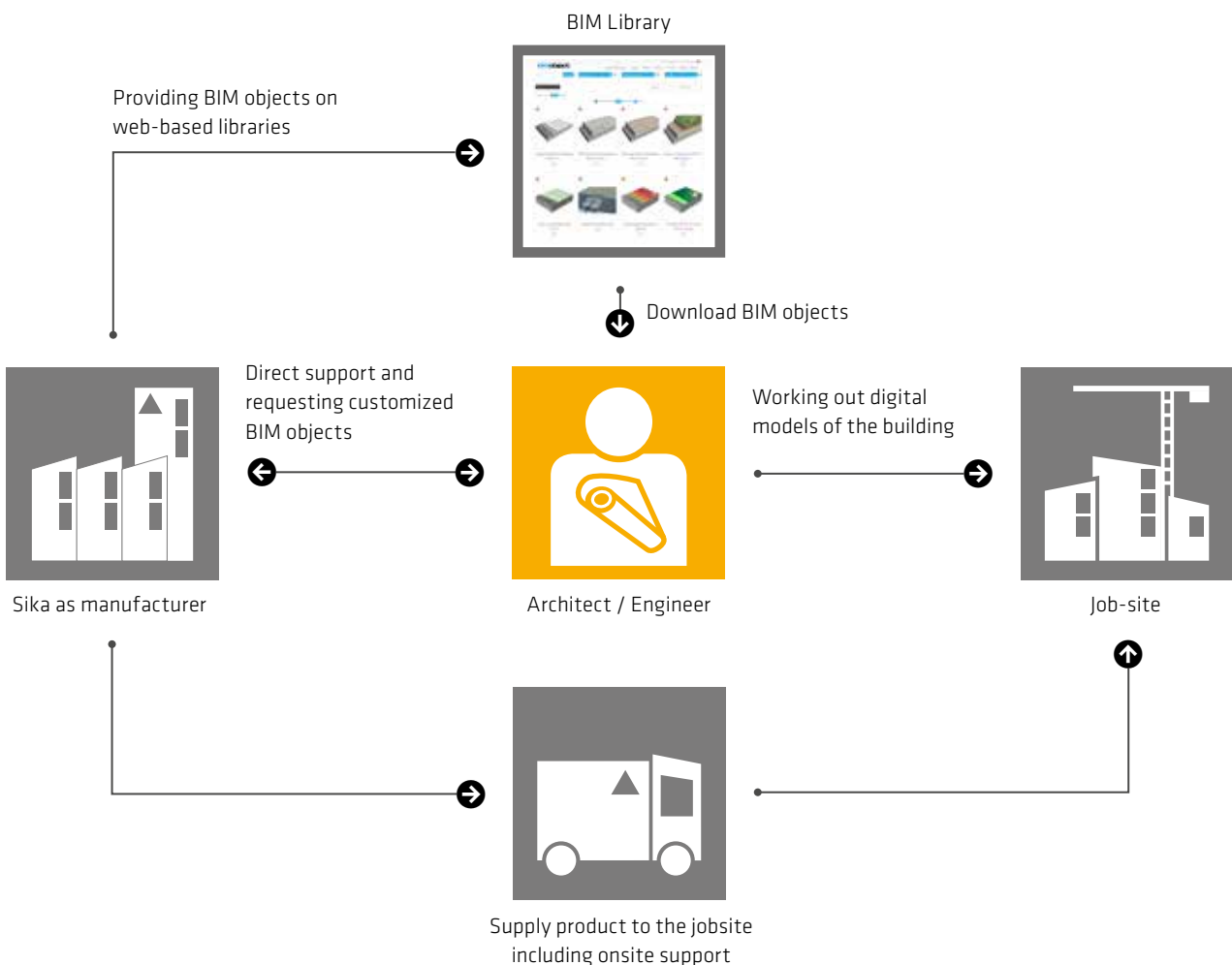

WE MAKE IT EASY FOR YOU to find the right BIM object and product data to match your specifications and requirements.

Sika provides a range of systems as BIM objects, embedded with product data and geometry. These objects can be integrated into your building information model to help accelerate the planning process and improve data quality.

Our current most popular BIM objects include:

Flooring

- Decorative, elastic polyurethane flooring system with Sika ComfortFloor® PS-23
- Robust, hard industrial and car parking deck flooring system with Sikafloor® MultiDur EB-24
- Industrial and commercial polyurethane-cement flooring system with Sikafloor® PurCem® HS-21 Gloss
- Prefabricated polymer composite panel for concrete floor joints with Sika® FloorJoint PD

Roofing

- Liquid-applied roofing system with Sikalastic®-641
- Mechanically-fastened warm roofing system with Sarnafil® S-327 (single-ply PVC membrane)
- Mechanically-fastened warm roofing system with Sarnafil® TS-77 (single-ply FPO membrane)
- Warm, extensive green roofing system with Sarnafil® TG-66 (single-ply FPO membrane)

Waterproofing

- Spray-applied waterproofing system for roofs, podiums and bridge decks with Sikalastic®-851 R or Sikalastic®-851
- Spray-applied waterproofing system for bridge decks and podiums with Sikalastic®-841 ST
- Spray-applied membrane system for podiums, basements and waterproofing with Sikalastic®-8800
- Spray-applied waterproofing system for car parking and bridge decks with Sikalastic®-8800 One Shot System
- Waterproofing tape system for joints and cracks with Sikadur Combiflex® SG
- Fully-bonded basement waterproofing membrane system with SikaProof® A and SikaProof® P.

If you don't see the Sika product you need in BIM format in the BIM library, please contact your local Sika company.



Sika BIM Library
To view and download Sika BIM
objects and learn how to use them,
please scan the QR code or visit:
www.sika.com/bim

SIKA FLOORING BIM OBJECTS

DECORATIVE, ELASTIC POLYURETHANE FLOORING SYSTEM WITH

Sika ComfortFloor® PS-23

Sika ComfortFloor® PS-23 is a highly elastic, decorative, polyurethane flooring system, which is ideal for use in healthcare (hospitals), educational (schools), commercial and residential buildings.

Characteristics / advantages:

- Smooth, dense surface with a silky, matt finish
- Good chemical resistance
- Seamless, impervious
- Comfortable, soft footfall
- Highly decorative with over 70 color options available
- Low VOC content, odorless
- Good wear resistance, resilient

BIM object buildup

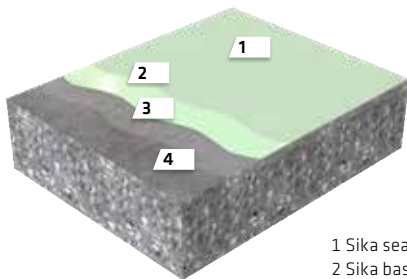

- 1 Sika sealer (e.g. Sikafloor®-305 W)
- 2 Sika base coat (e.g. Sikafloor®-330) (typical 2 - 3 mm thickness)
- 3 Sika primer (e.g. Sikafloor®-156 or -161 or -160)
- 4 Substrate (e.g. concrete or cementitious screed - to be adjusted by BIM user)

BIM object features:

- You can choose the specified thickness depending on use.
- You can choose your flooring color from the included RAL color chart.
- Available in Revit (.rvt) or ArchiCAD (.gsm) formats.
- Color chart available for download.



To view and download this Sika BIM object, please scan the QR code or visit:
http://bimobject.com/en/sika/product/comfortfloor_ps-23

ROBUST, HARD INDUSTRIAL AND CAR PARKING DECK FLOORING SYSTEM WITH

Sikafloor® MultiDur EB-24

Sikafloor® MultiDur EB-24 is a robust, hard industrial flooring system with a textured anti-slip surface, which is designed for use in areas where slip resistance, medium chemical and high mechanical resistance is required. It is ideal for use in car parking decks.

Characteristics / advantages:

- High mechanical resistance
- Good chemical resistance
- Seamless
- Anti-slip surface
- Over 200 colors available

BIM object buildup

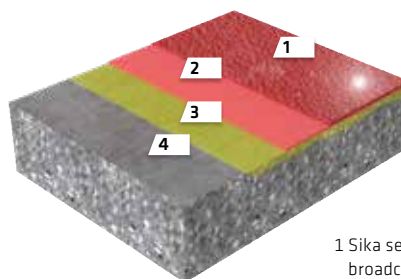

- 1 Sika sealer (e.g. Sikafloor®-264) and broadcast
- 2 Sika base coat (e.g. Sikafloor®-263 SL) (typical 2 - 4 mm thickness)
- 3 Sika primer (e.g. Sikafloor®-156 or -161 or -160)
- 4 Substrate (e.g. concrete or cementitious screed - to be adjusted by BIM user)

BIM object features:

- You can choose the specified thickness depending on use.
- You can choose your flooring color from the included RAL color chart.
- Available in Revit (.rvt) or ArchiCAD (.gsm) formats.
- Color chart available for download.



To view and download this Sika BIM object, please scan the QR code or visit:
http://bimobject.com/en/sika/product/multidur_eb-24

INDUSTRIAL AND COMMERCIAL POLYURETHANE-CEMENT FLOORING SYSTEM WITH

Sikafloor® PurCem® HS-21 Gloss

Sikafloor® PurCem® HS-21 Gloss is an industrial and commercial flooring system based on polyurethane-cement hybrid technology. Primary uses include: industrial areas, coolers, "back of house" service areas, storage rooms, kitchens and ground floor garages.

Characteristics / advantages:

- Hard, glossy and smooth surface
- High scratch resistance, dense and impervious
- Very good chemical resistance
- Seamless
- Low dirt pick-up, easy to keep clean and maintain
- Odorless, VOC free and environmental friendly
- Can be applied on concrete substrates with high moisture content

BIM object buildup

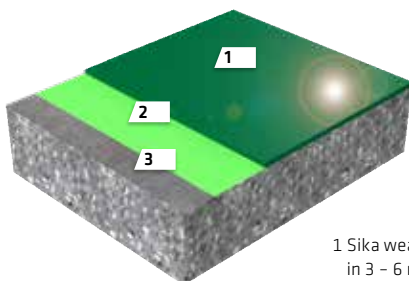

- 1 Sika wear coat (normally applied in 3 – 6 mm thickness)
- 2 Sika primer
- 3 Substrate (e.g. concrete or cementitious screed – to be adjusted by BIM user)

BIM object features:

- Choose your specified buildup by adjusting sealer and base coat thickness.
- Customize your finish by selecting from many colors available from the included RAL color chart.
- Available in Revit (.rvt) or ArchiCAD (.gsm) formats.
- Color chart available for download.



To view and download this Sika BIM object, please scan the QR code or visit:
http://bimobject.com/en/sika/product/purcem_hs-21_gloss

PREFABRICATED POLYMER COMPOSITE PANEL FOR CONCRETE FLOOR JOINTS WITH

Sika® FloorJoint PD

Sika® FloorJoint PD is a vibration-free, prefabricated carbon-fiber-reinforced polymer composite panel for concrete floor joints. It is designed for use in car parking decks, commercial buildings and industrial floors.

Characteristics / advantages:

- Ultra flat, invisible and fits seamlessly into the floor
- Can be recoated with Sikafloor® flooring systems
- Noiseless and vibration-free under traffic
- Waterproof, good chemical resistance
- Corrosion-free, made of resin
- High movement capacity
- Fast, easy installation and easy repair

BIM object buildup

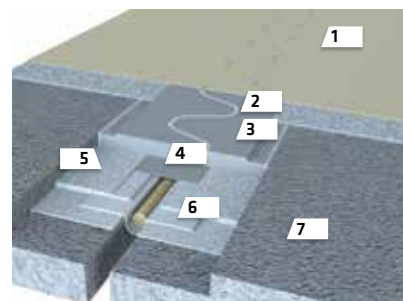

- 1 Sika flooring system with Sika top coat (e.g. Sikafloor®-359 or -378)
- 2 Sikaflex® sealant
- 3 Sika® FloorJoint PD
- 4 Masking tape
- 5 Sika primer (e.g. Sikadur®-30 Normal)
- 6 Sikadur® Combiflex® system and backer rod
- 7 Prepared substrate (e.g. concrete – to be adjusted by BIM user)

BIM object features:

- Easily and quickly place the floor joint component into your BIM model.
- Customize length of floor joint required for your project.
- Available in Revit (.rvt/.rfa) or ArchiCAD (.gsm) formats.



To view and download this Sika BIM object, please scan the QR code or visit:
http://bimobject.com/en/sika/product/floorjoint_pd

SIKA ROOFING BIM OBJECTS

LIQUID-APPLIED ROOFING SYSTEM WITH

Sikalastic®-641

Liquid-applied membrane

Sikalastic®-641 is a low odor polyurethane membrane, which cures to form a seamless, durable and weather-resistant waterproofing solution for exposed roof areas.

Characteristics / advantages:

- Single component – no mixing, easy to use
- Cold applied – requires no heat or flame
- Special odor reducing hardener technology
- Suitable for odor sensitive projects such as hospitals, schools, public buildings, etc.
- Easily recoated when needed – no stripping required
- Economic – provides a cost efficient life cycle extension of failing roofs
- Vapor permeable- allows substrate to breathe
- Elastic – retains flexibility even at low temperatures
- Good adhesion to most substrates
- Fast curing

BIM object buildup

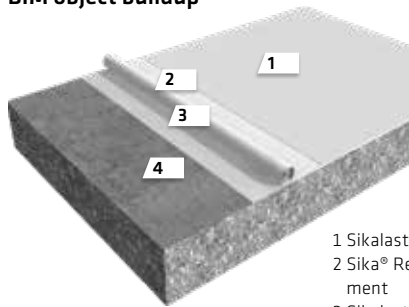

- 1 Sikalastic®-641 top coat
- 2 Sika® Reemat Standard reinforcement
- 3 Sikalastic®-641 base coat
- 4 Prepared substrate and roof structure (to be adjusted by BIM user)

BIM object features:

- You can select the roofing membrane thickness and color from the included color chart.
- You can adjust the roof structure and substrate to suit your project.
- Available in Revit (.rvt) or ArchiCAD (.gsm) formats.



To view and download this Sika BIM object, please scan the QR code or visit:
http://bimobject.com/en/sika/product/sikalastic_641

MECHANICALLY-FASTENED WARM ROOFING SYSTEM WITH

Sarnafil® S-327

Single-ply PVC membrane

Sarnafil® S-327 is a polyester reinforced, multi-layer, synthetic roof waterproofing sheet based on premium-quality polyvinyl chloride (PVC) containing ultraviolet light stabilizers and flame retardant.

Characteristics / advantages:

- Outstanding resistance to weathering, including permanent UV irradiation
- Excellent flexibility in cold temperatures
- No built-in stress at time of production
- High dimensional stability
- High water vapor permeability
- Excellent weldability
- No risk of delamination or water-wicking
- Can be produced in different colors
- Lacquer-coated surface
- Recyclable

BIM object buildup

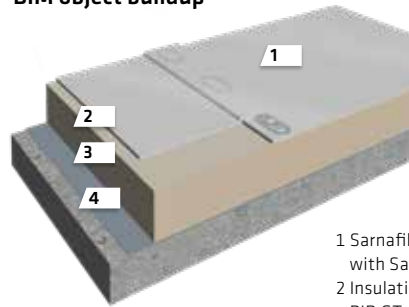

- 1 Sarnafil® S-327 roofing membrane with Sarnafast fastening elements
- 2 Insulation (Sarnatherm® PIR AL, PIR GT, EPS, XPS or mineral wool)
- 3 Sarnavap®-1000 E vapor control layer
- 4 Prepared substrate and roof structure (to be adjusted by BIM user)

BIM object features:

- You can choose the insulation type and thickness.
- You can select the roofing membrane thickness and color from the included color chart.
- You can adjust the roof structure and substrate to suit your project.
- Available in Revit (.rvt) or ArchiCAD (.gsm) formats



To view and download this Sika BIM object, please scan the QR code or visit:
http://bimobject.com/en/sika/product/sarnafil_s_327

MECHANICALLY-FASTENED WARM ROOFING SYSTEM WITH

Sarnafil® TS-77

Single-ply FPO membrane

Sarnafil® TS-77 is a polyester reinforced, multi-layer, synthetic roof waterproofing sheet based on premium-quality flexible polyolefins (FPO) containing ultraviolet light stabilizers, flame retardant and a non-woven glass inlay.

Characteristics / advantages:

- Outstanding resistance to weathering, including permanent UV irradiation
- Excellent flexibility in cold temperatures
- No built-in stress at the time of production
- High dimensional stability
- High resistance against impact load
- Excellent weldability
- No risk of delamination or water-wicking
- Can be produced in different colors
- Compatible with old bitumen
- Recyclable

BIM object buildup

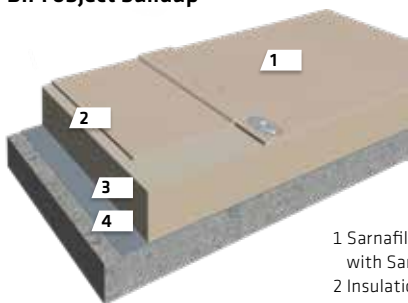

- 1 Sarnafil® TS-77 roofing membrane with Sarnafast fastening elements
- 2 Insulation (Sarnatherm® PIR AL, PIR GT, EPS, XPS or mineral wool)
- 3 Sarnavap®-2000 E vapor control layer
- 4 Prepared substrate and roof structure (to be adjusted by BIM user)

BIM object features:

- You can choose the insulation type and thickness.
- You can select the roofing membrane thickness and color from the included color chart.
- You can adjust the roof structure and substrate to suit your project.
- Available in Revit (.rvt) or ArchiCAD (.gsm) formats



To view and download this Sika BIM object, please scan the QR code or visit:
http://bimobject.com/en/sika/product/sarnafil_ts_77

WARM, EXTENSIVE GREEN ROOFING SYSTEM WITH

Sarnafil® TG-66

Single-ply FPO membrane

Sarnafil® TG-66 is a multi-layer, synthetic roof waterproofing sheet based on premium-quality flexible polyolefins (FPO), containing stabilizers, with a non-woven glass inlay.

Characteristics / advantages:

- Outstanding resistance to weathering, including permanent UV irradiation
- Excellent flexibility in cold temperatures
- No built-in stress at the time of production
- High dimensional stability
- High resistance against impact load
- Excellent weldability
- No risk of delamination or water-wicking
- Can be produced in different colors
- Compatible with old bitumen
- Recyclable

BIM object buildup

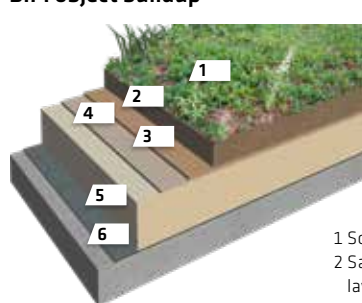

- 1 Soil with plants/vegetation
- 2 Sarnavert® Aquadrain-550 drainage layer
- 3 Sarnafil® TG-66 roofing membrane
- 4 Insulation (Sarnatherm® PIR GT, PIR AL, EPS, XPS or mineral wool)
- 5 Sarnavap®-3000 M vapor control layer
- 6 Prepared substrate and roof structure (to be adjusted by BIM user)

BIM object features:

- You can choose the insulation type and thickness.
- You can select the roofing membrane thickness.
- You can adjust the roof structure and substrate to suit your project.
- Available in Revit (.rvt) or ArchiCAD (.gsm) formats



To view and download this Sika BIM object, please scan the QR code or visit:
http://bimobject.com/en/sika/product/sarnafil_tg_66

SIKA WATERPROOFING BIM OBJECTS

SPRAY-APPLIED WATERPROOFING SYSTEM FOR ROOFS, PODIUMS AND BRIDGE DECKS WITH

Sikalastic®-851 R/851

Sikalastic®-851 R and Sikalastic®-851 are liquid-applied polyurethane/polyurea-hybrid waterproofing solutions for use on concrete on flat, pitched or green roofing systems, on podium areas beneath planted or hard landscaping and on bridge decks.

Characteristics / advantages:

- Fast application to reduce down time
- Improved adhesion reduces maintenance costs and increases safety for vehicles
- Elastic crack-bridging properties under a wide range of temperatures
- Resistance to chlorides and aggressive chemicals
- Root resistant
- Lightweight system
- For new construction or refurbishment

BIM object buildup

For podiums (BBA approved system)

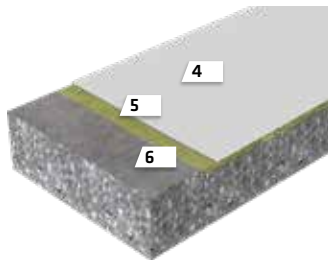

For bridge decks (BBA approved system)

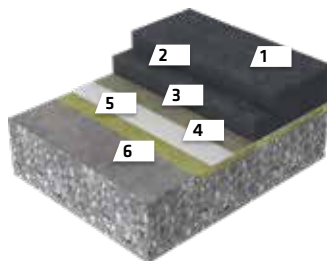

For roofs and podiums
(non-BBA approved system)

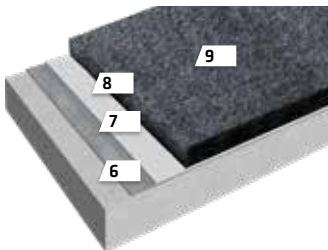

- 1 Asphalt wear course
- 2 Asphalt base course
- 3 Tack coat system: Sikalastic®-8901 primer with Sikalastic®-827 HT pellets
- 4 Sikalastic®-851 waterproofing membrane
- 5 Sikadur®-188 (Normal or Rapid) primer with quartz sand
- 6 Concrete substrate
- 7 Sikafloor®-161 or Sika® Concrete Primer with quartz sand
- 8 Sikalastic®-851 R waterproofing membrane
- 9 Optional protection or drainage board layer (e.g. Sika® Drain-850 Geo)

BIM object features:

- You can quickly select the buildup which suits your project.
- You can adjust the roof structure or substrate to suit your project.
- Available in Revit (.rvt) or ArchiCAD (.gsm) formats



To view and download this Sika BIM object, please scan the QR code or visit:
http://bimobject.com/en/sika/product/sikalastic_851_r_851

SPRAY-APPLIED WATERPROOFING SYSTEM FOR BRIDGE DECKS AND PODIUMS WITH

Sikalastic®-841 ST

Sikalastic®-841 ST is a high performance liquid-applied polyurea based waterproofing solution for concrete, which is ideal for bridge decks and podiums.

Characteristics / advantages:

- Fast application to reduce down time
- Improved adhesion reduces maintenance costs and increases safety for vehicles
- Elastic crack-bridging properties under a wide range of temperatures
- Resistance to chlorides and aggressive chemicals
- Lightweight system
- For new construction or refurbishment

BIM object buildup

For bridge decks (ETA & BBA approved system)

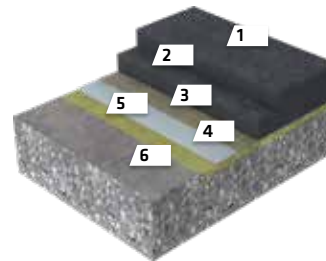

For podiums

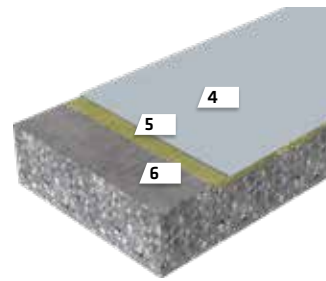

- 1 Optional asphalt overlay
- 2 Asphalt base course
- 3 Tack coat system: Sika® Concrete Primer with Sikalastic®-827 HT pellets
- 4 Sikalastic®-841 ST waterproofing membrane
- 5 Sika® Concrete Primer with quartz sand
- 6 Concrete substrate

BIM object features:

- You can quickly select the buildup which suits your project.
- You can adjust the substrate to suit your project
- Available in Revit (.rvt) or ArchiCAD (.gsm) formats



To view and download this Sika BIM object, please scan the QR code or visit:
http://bimobject.com/en/sika/product/sikalastic_841_st

SPRAY-APPLIED MEMBRANE SYSTEM FOR PODIUMS, BASEMENTS AND WATERPROOFING WITH

Sikalastic®-8800

Sikalastic®-8800 is a two-part, liquid-applied, elastic, pure-polyurea membrane for use in a wide variety of waterproofing applications, such as podiums, basements and more.

Characteristics / advantages:

- Fast application to reduce down time
- Elastic crack-bridging properties under a wide range of temperatures
- Resistance to chlorides and aggressive chemicals such as fuel, oils and hydraulic fluids
- Lightweight, root-resistant system
- Can be used in conjunction with SikaProof® A/P or Sikaplan®

BIM object buildup

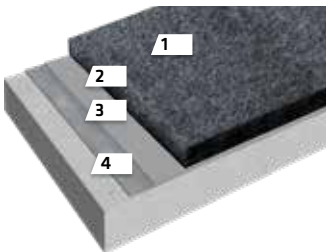

- 1 Optional protection or drainage board layer (e.g. Sika® Drain-850 Geo)
- 2 Sikalastic®-8800 waterproofing membrane
- 3 Sikafloor®-161 or Sika® Concrete Primer with quartz sand
- 4 Concrete substrate

BIM object features:

- You can quickly place the object into your BIM project.
- You can adjust the roof structure or substrate to suit your project.
- Available in Revit (.rvt) or ArchiCAD (.gsm) formats



To view and download this Sika BIM object, please scan the QR code or visit:
http://bimobject.com/en/sika/product/sikalastic_8800

SPRAY-APPLIED WATERPROOFING SYSTEM FOR CAR PARKING AND BRIDGE DECKS WITH

Sikalastic®-8800 ONE SHOT SYSTEM

Sikalastic®-8800 One Shot System is a practical, fast-applied car parking deck and bridge deck waterproofing system combining polyurea and aggregates in an innovative application method.

Characteristics / advantages:

- Fast application to reduce down time – directly trafficable
- Elastic crack-bridging properties under a wide range of temperatures
- System without asphalt overlay
- Very high mechanical and abrasion resistance
- Excellent corrosion protection

BIM object buildup

For concrete car parking or bridge decks

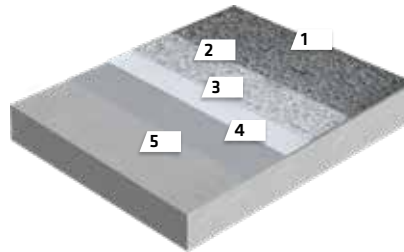

- 1 Top coat (e.g. Sikafloor®-359 or -378)
- 2 Sikalastic®-8800 wear coat with aggregate injection
- 3 Sikalastic®-8800 waterproofing membrane
- 4 Sikafloor®-161 or Sika® Concrete Primer with quartz sand
- 5 Concrete substrate

For steel car parking or bridge decks

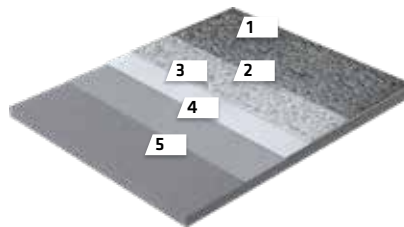

- 6 SikaCor® Elastomastic Airless primer
- 7 Steel substrate

BIM object features:

- You can quickly select the buildup which suits your project.
- You can adjust the substrate to suit your project.
- Available in Revit (.rvt) or ArchiCAD (.gsm) formats



To view and download this Sika BIM object, please scan the QR code or visit:
http://bimobject.com/en/sika/product/sikalastic_8800_one-shot-system

SIKA WATERPROOFING BIM OBJECTS

WATERPROOFING TAPE SYSTEM FOR CRACKS AND JOINTS WITH

Sikadur Combiflex® SG

The Sikadur Combiflex® SG system includes Sikadur Combiflex® SG tape and Sikadur® adhesives. With improved performance and advanced adhesion properties, it can be directly applied as joint waterproofing or over crack zones preventing leakage occurrence. Common applications include: basements, facade joints, bridges, tunnels, swimming pools, drinking water and groundwater protection and more.

We also provide entire system solutions for your project's waterproofing needs, including Sika® Watertight Concrete, concrete mix design and other joint sealing solutions (e.g. waterbars, injections, tiebars, etc.).

Characteristics / advantages:

- Post-applied waterproofing of joints or cracks
- Excellent adhesion to different substrates
- Resistant to high water pressure
- Easy to install and adjust to complicated construction details
- Can be applied over original failing material
- Joint waterproofing with extreme movements
- Crack sealing system
- Easy to control and repair
- Fully bonded to concrete preventing underflow

BIM object features:

- Easily and quickly place the waterproofing component into your BIM model.
- Customize waterproofing tape width and length required for your project.
- Embedded Sika® Watertight Concrete mix design specifications
- Available in Revit (.rvt/.rfa) or ArchiCAD (.gsm) formats

System for Cracks

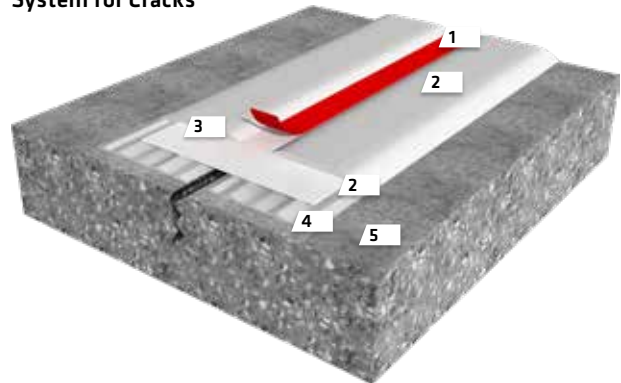

System for Joints

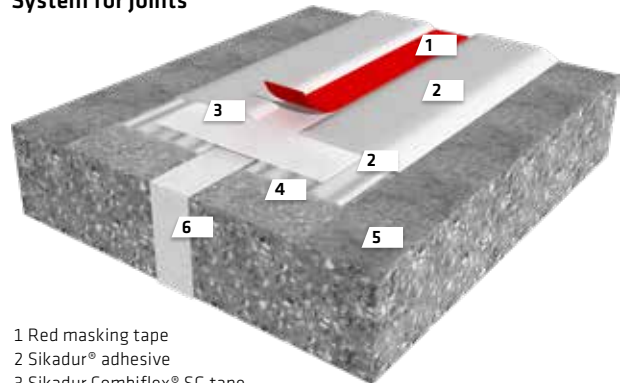

- 1 Red masking tape
- 2 Sikadur® adhesive
- 3 Sikadur Combiflex® SG tape
- 4 Prepared concrete surface
- 5 Joint filler
- 6 Sika® Watertight Concrete

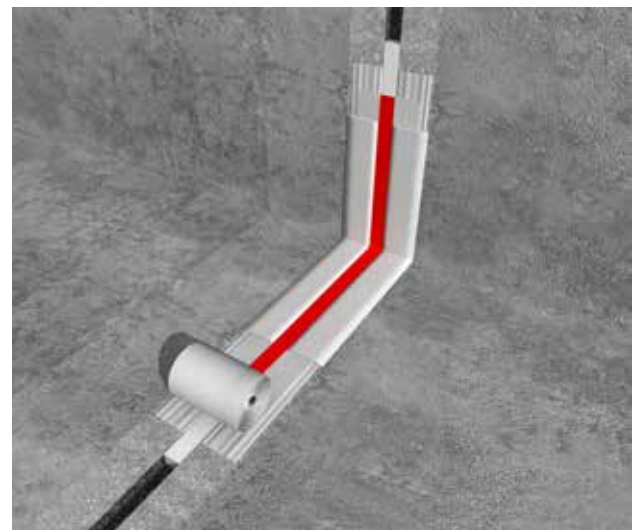

To view and download this Sika BIM object, please scan the QR code or visit:
http://bimobject.com/en/sika/product/sikadur_combiflex_sg

FULLY-BONDED BASEMENT WATERPROOFING MEMBRANE SYSTEM WITH

SikaProof® A and SikaProof® P

SikaProof® A and SikaProof® P are pre-applied or post-applied fully-bonded waterproofing membranes which are easy-to-install and ideal for dampproofing or waterproofing basements and below-grade structures. These highly-flexible FPO membrane systems are a reliable, durable solution which can be used for new structures, renovating existing basements and a variety of more demanding applications, whether you want to keep water in or keep water out.

As a waterproofing system provider, Sika provides a range of compatible products, such as concrete mix design and joint sealing solutions.

Characteristics / advantages:

- Pre-applied (A) or post-applied (P) waterproofing systems
- Time and cost efficient, easy and quick installation; no hot-air welding required
- Highly-flexible FPO membrane
- Fully-bonded system, no lateral water underflow
- High durability, long lasting
- Can be easily and efficiently repaired using local resin injection

BIM object features:

- Quickly understand our basement waterproofing solutions in 3D.
- Easily and quickly place the selected system component into your BIM model.
- Customize dimensions of the system required for your project.
- Available in Revit (.rvt) or ArchiCAD (.gsm) formats.

SikaProof® for Vertical Excavation and Construction with Piled or Diaphragm Walls

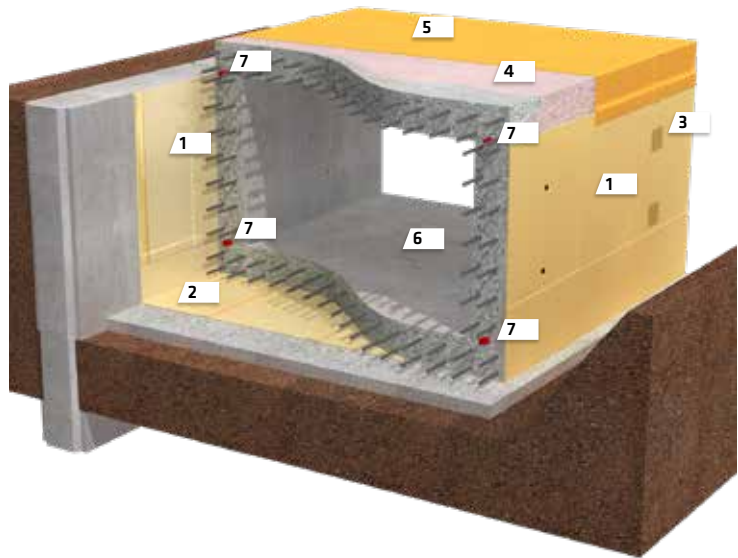

SikaProof® for Open-cut Excavation

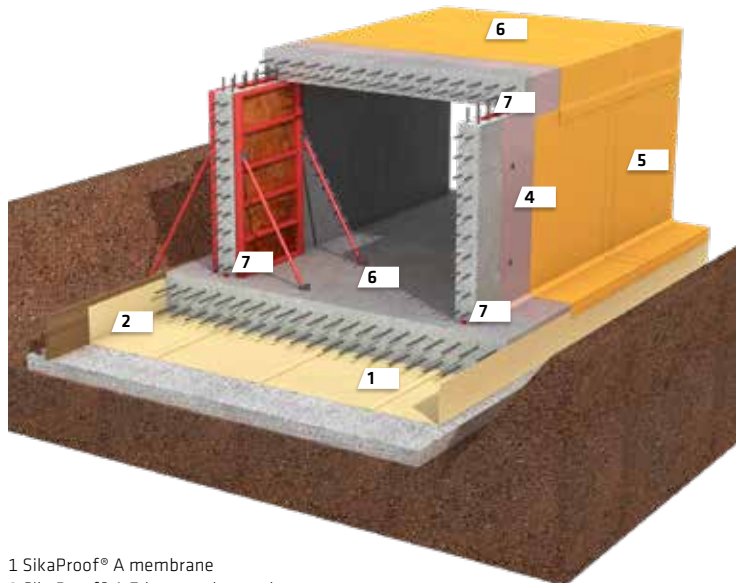

- 1 SikaProof® A membrane
- 2 SikaProof® A Edge membrane sheet
- 3 SikaProof® Patch-200 B
- 4 SikaProof® Primer-01
- 5 SikaProof® P membrane
- 6 Cast-in-place concrete
- 7 Joint solution, SikaSwell® A and S-2



To view and download this Sika BIM object,
please scan the QR code or visit:
http://bimobject.com/en/sika/product/sikaproof_a-p

BIM CASE STUDIES

WHEN BIM HAS BEEN USED in projects where Sika product is specified, we have been able to provide BIM support. Here is an inside look at two such BIM reference projects.



KERRY GLOBAL TECHNOLOGY AND INNOVATION CENTER IN KILDARE, IRELAND

PROJECT DESCRIPTION

The Kerry Group's Global Technology and Innovation Centre in Naas, Co Kildare in Ireland is one world class project which benefited from the use of BIM. Officially opened in 2015, this €100 million project sits on a 28-acre site.

PROJECT REQUIREMENTS

For the project's roofing component, Sika was approached by the project design team with two requirements. Firstly, the specification for the roofing membrane had to be 'LEED' accredited, and Sika has a range of products that meet this criteria. Secondly, the project would have to be designed and built through the utilization of BIM, where all roofing details had to be in BIM format.

SIKA SOLUTION

Sika was able to satisfy both requirements with their Sarnafil® S 327-18 EL membrane in solar reflective 'Traffic White' color. This membrane satisfied the 'LEED' requirement with a solar reflective index over 78. The architect was able to easily download the BIM objects from the local BIM library.



FIRST DIRECT ARENA IN LEEDS, UK

PROJECT DESCRIPTION

Opened in 2013, the First Direct Arena in Leeds quickly fulfilled its aim to provide an impressive venue to attract big names. With its unique honeycombed facade and kaleidoscopic lighting, the UK's first 'fan-shaped' arena has become one of Yorkshire's most iconic buildings. This 13,500-capacity concert and events space has proven to be a favored venue after being voted 'Best New Venue in the World' in 2014.

PROJECT REQUIREMENTS

Alongside the main contractor BAM Construction and architect Populous, the experienced contractor Lakesmere executed the project as its first BIM-integrated contract, where clash detection of 3D geometry was essential to its successful delivery. Also, due to the venue's proximity to residential areas, the team had to overcome environmental and noise considerations when installing the roof. Therefore, it was vital that the arena's roof adhere to local building regulation criteria.

SIKA SOLUTION

The desired acoustic performance in the arena was achieved by specifying Sika Sarnafil S 327-18 EL 'Copper Patina' color along with suitable insulation on the 7,500 m² main auditorium roof. This single-ply roofing system also has outstanding resistance to weathering, including permanent UV radiation and flexibility in colder weather. In keeping with the projects' sustainable design, the roof's complex gutter system was installed in Sika Sarnafil S 327-15 EL 'Light Grey' color, and a small green roof was provided using the Sarnavert system. Sika Sarnafil was the first roofing manufacturer in the UK to be BIM ready. This can play a huge part in the specification and improves the ability to review designs and rationalize ideas.

THINK BIM
ROOFING
FLOORING
WATERPROOFING
THINK SIKA





Harbin Opera House - China
Architect: MAD
BIM: Gehry Technologies Co., Ltd.
The facade's glass pyramids are bonded with Sikasil® sealants.

GLOBAL BUT LOCAL PARTNERSHIP

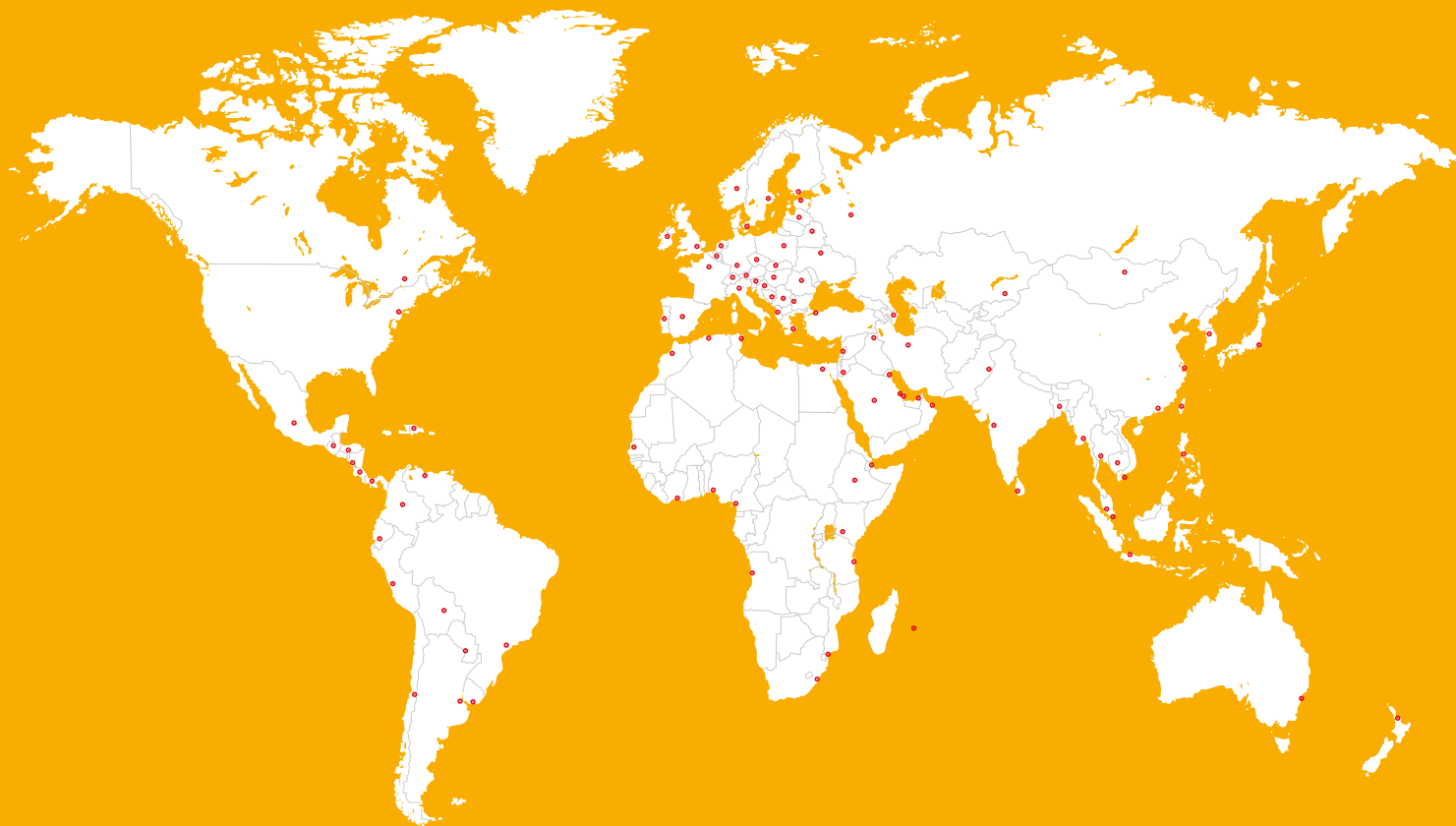

FOR MORE INFORMATION ABOUT SIKA AND BIM:



WE ARE SIKA

Sika is a specialty chemicals company with a leading position in the development and production of systems and products for bonding, sealing, damping, reinforcing and protecting in the building sector and the motor vehicle industry. Sika's product lines feature concrete admixtures, mortars, sealants and adhesives, structural strengthening systems, flooring as well as roofing and waterproofing systems.

Our most current General Sales Conditions shall apply. Please consult the most current local Product Data Sheet prior to any use.



SIKA SERVICES AG
Tueffenwies 16
CH-8048 Zurich
Switzerland

Contact
Phone +41 58 436 40 40
Fax +41 58 436 41 50
www.sika.com

BUILDING TRUST

