



REFURBISHMENT SIKA TECHNOLOGIES AND SOLUTIONS FOR WASTE WATER TREATMENT PLANTS

BUILDING TRUST





SIKA – YOUR PARTNER

Since many decades Sika has been a reliable partner with waste water treatment plant contractors supplying products and systems on all continents. Sika has shown the industry we are a partner, they can trust. The products and systems used in new waste water treatment plants and retrofitted structures are thoroughly tested in Sika laboratories before being independently checked. Sika materials are further proven by long term site testing to withstand the harsh conditions in the real environment.

CONTENT

04	Sika Solutions Contribute to a Sustainable Future Sustainable Refurbishment of Waste Water Treatment Plants General Process of Cleaning Waste Water
10	Exposure for Sewers Sika Solutions for Sewers
14	Problems and Damages to Structures
16	Aggressive Substances in Sewage – Sustained Attack on Concrete
18	Sika's Field Experience since 1991
20	General Sewage Treatment Plant Refurbishment Consideration General Sewage Treatment Plant Refurbishment Procedures
22	Overview of Sika Solutions Sika Solutions for Screening Channels Sika Solutions for Grit, Fat and Grease Chambers Sika Solutions for Screening Primary Sedimentation Tanks Sika Solutions for Biological Tanks Sika Solutions for Gasometer Sika Solutions for Digestion Tanks Sika Solutions for Secondary Sedimentation Tanks Sika Solutions for Filtration Beds Sika Solutions for Technical Service Buildings and Weathering Protection Sika Solutions for New Constructions More Sika Solutions
46	Case Studies

SIKA SOLUTIONS CONTRIBUTE TO A SUSTAINABLE FUTURE

“SIKA IS COMMITTED TO PUTTING HIGH-PERFORMANCE SOLUTIONS into practice – to the benefit of our customers and for a sustainable development.”

Distribution of earth's water

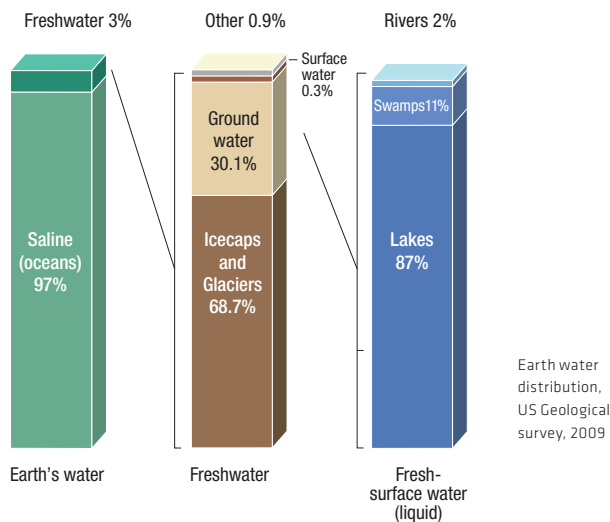

The fresh water available on the earth amounts to only 3% of the total water – the balance being saline water from seas and oceans. Rivers and lakes that supply most of the water for the human uses only constitute 0.007% of the total water (source: US geological survey, 2009). From these figures alone, it is

clear that we should do the maximum to minimize pollution of our rivers and lakes. Waste water from urban and agricultural areas is one of the most significant sources of pollution. There is a wide diversity in the world regarding access to waste water treatment. While 90% of the waste water produced globally remains untreated, this situation is reversed in developed countries – for example, around the Lake Geneva, more than 95% of the population is connected to a sewage treatment plant.

Sika contributes to saving water in the planet by providing sustainable construction and refurbishment solutions to extend the functional service life of waste water treatment plants.

SIKA SOLUTIONS TO REDUCE WASTE!

In a remedial work, significant amount of waste is generated: polluted concrete, chemical residue of old coatings, pails and bags. These wastes need to be disposed off in specific areas and contribute to CO₂ emission. Sika provides long-lasting repair and protection systems that help to extend the interval between maintenance and remedial work. Thanks to this, the quantity of waste is significantly reduced.



THE SIKA LIFE CYCLE ASSESSMENT APPROACH

Life Cycle Assessment (LCA) is a standardized method to assess and compare the inputs, outputs and potential environmental impacts of products and services over their life cycle. LCA's are increasingly recognized as the best way to evaluate the sustainability of products and systems.

Sika carries out LCA's according to the ISO 14040 series and the Standard EN 15804. The impact assessment methodology used is CML 2001. The data for the Sika LCA is based on public databases, such as those from ecoinvent, the European Reference Life Cycle Database (ELCD) and PE-GaBi, plus the specific data from Sika production plants and products.

Cumulative Energy Demand (CED), Global Warming Potential (GWP) and Photochemical Ozone Creation Potential (POCP) are considered to be the most relevant for concrete repair and protection:

- Cumulative Energy Demand (CED) is the total amount of primary energy from renewable and non-renewable resources.
- Global Warming Potential (GWP) is the potential contribution to climate change due to greenhouse gases emissions.

- Photochemical Ozone Creation Potential (POCP) is the potential contribution to summer smog, related to ozone induced by sunlight on volatile organic compounds (VOC) and nitrous oxides (NOx).

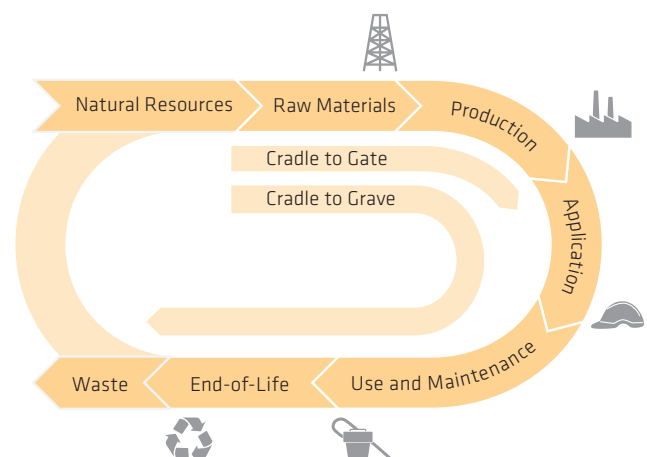



SUSTAINABLE REFURBISHMENT OF WASTE WATER TREATMENT PLANTS

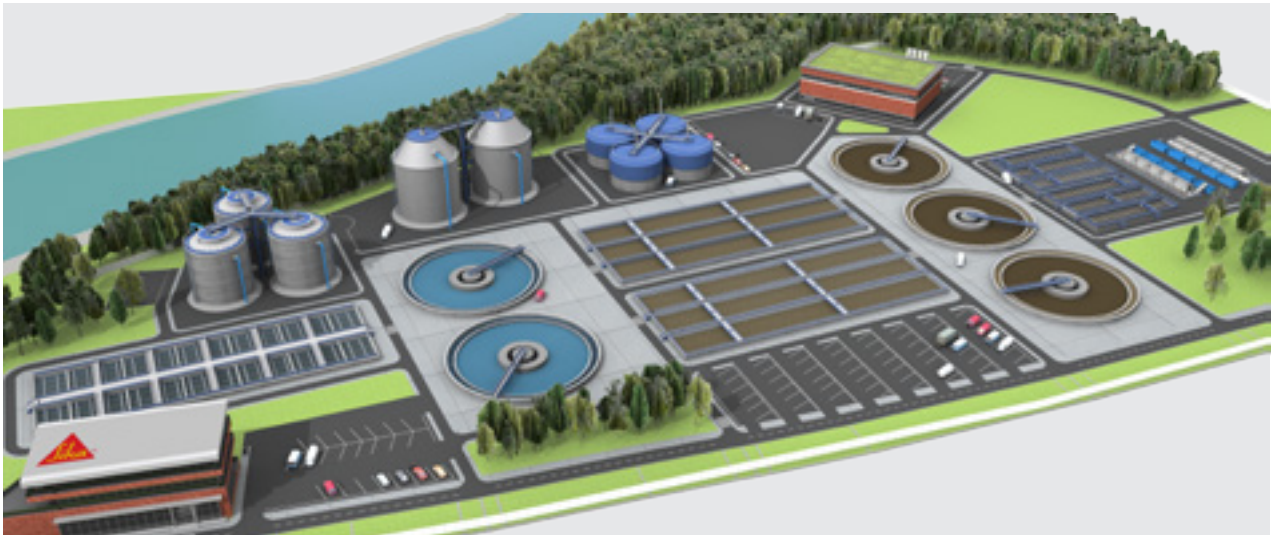

Sika LCA's on refurbishment strategies for waste water treatment plants are based on a 'Cradle to Grave' approach. Potential environmental impact of products for concrete repair and protection is investigated from raw material extraction, production, application and use to final disposal at end of life.

Construction and end-of-life scenario of the reinforced concrete structure itself is excluded. Two different scenarios of refurbishment are analyzed – see below:

Biological tank

1000 m² exposed surface, reinforced concrete without initial protection. First refurbishment after 20 years of use

	Scenario 1: Minimum investment	Scenario 2: Durable solutions
Initial repair	Ultra high pressure water jetting, reinforcement corrosion protection and concrete repair	Ultra high pressure water jetting, reinforcement corrosion protection and concrete repair
Concrete protection	Polymer modified cementitious resurfacing mortar	Sikagard®-720 EpoCem® Epoxy cement resurfacing mortar Sikagard®-63 N High build epoxy coating
Life span based on field investigation	7.5 years	20 years
Life span for LCA	10 years	20 years
Refurbishment & refreshing (every cycle)	<ul style="list-style-type: none"> ■ Ultra high pressure water jetting ■ Reinforcement corrosion protection ■ Concrete repair ■ Polymer modified cementitious resurfacing mortar 	Sikagard®-63 N High build epoxy coating (refreshing coat)

Sikagard® state of the art concrete protection system with field proven durability allows 40 years of operation with only one short shut down period for refreshing the top coat.

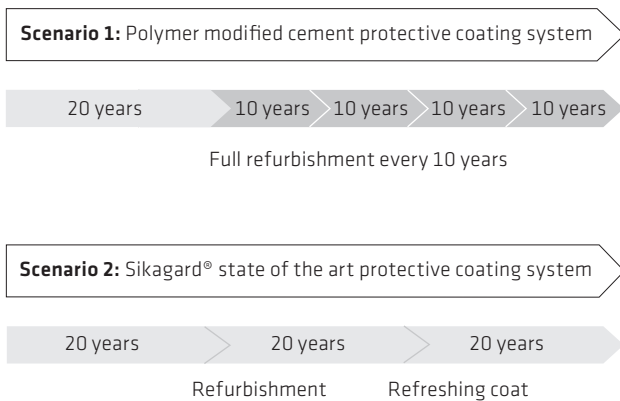

Photochemical Ozone Creation Potential (POCP)

(per 1000 m², for life cycle of 60 years)

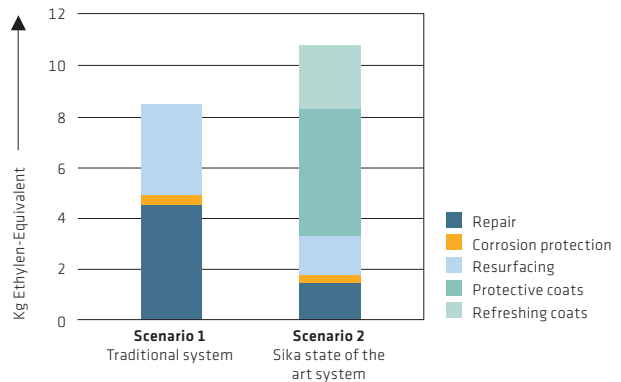

Scenario 2 has a higher POCP impact due to the use of epoxy coating. However, the impact to the environment is minimal. The difference between the two scenarios over the life cycle period (60 years) is only 2.5 Kg of Ethylen equivalent. This represents only 40 g per year (~1 bottle of nail polish remover per year).

Cumulative Energy Demand (CED)

(per 1000 m², for life cycle of 60 years)

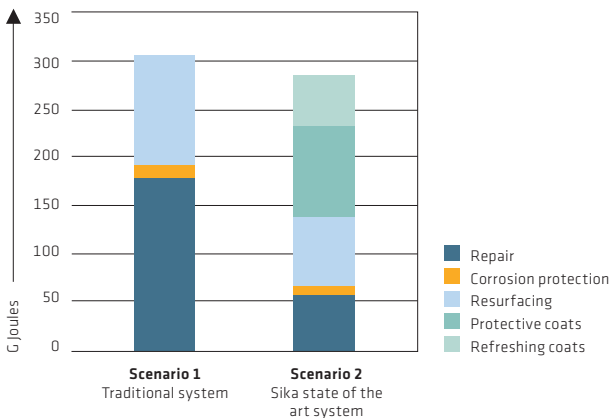

Even when using epoxy based materials to increase durability, **scenario 2** has a slightly lower CED than scenario 1 due to its greater resource efficiency (lower material consumption over the whole life cycle). This is an equivalent saving of 550 liters of oil over the life cycle period (60 years).

Global Warming Potential

(per 1000 m², for life cycle of 60 years)

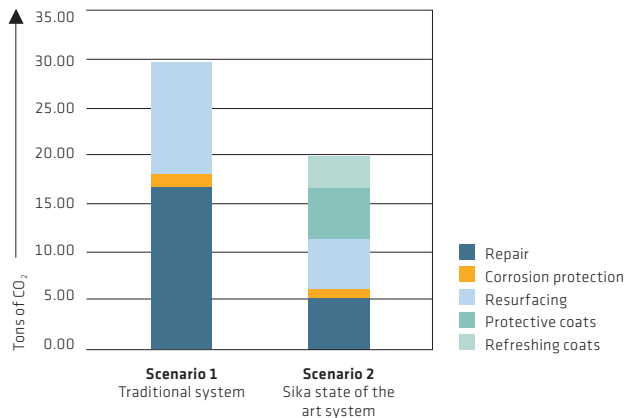

The greater resource efficiency of **scenario 2** allows savings of 10 tons of CO₂ over the life cycle period (60 years). Comparing this value to the limit of the European Union strategy adopted in 2007 (not more than 130 g of CO₂ per km in 2015), this saving is equivalent to a car's CO₂ emission during ~1'300 km per year.

CONCLUSION

Overall saving for the plant owner with positive incidence on sustainability:

The appropriate strategy can have a beneficial impact:

- by reducing the frequency of refurbishment cycles,
- by improving the resource efficiency and the environmental performance of the refurbishment process,
- by providing a more sustainable solution.

GENERAL PROCESS OF CLEANING WASTE WATER

The cleaning procedure of a modern waste water treatment plant can be summarized in 6 different steps:

SEWER SYSTEM

see pages 10 - 13

Generally, waste water is collected and transported via a network of pipes and pumped to the waste water treatment plant.

MECHANICAL TREATMENT

see pages 24 to 29 and 38/39

This includes the screening to remove large objects in the sewage water and the whole sedimentation procedure as well. Sand and grits, oil, grease, fat, floating and heavy solids will be separated from the waste water. The primary sludge after settlement will be skimmed off.

Construction elements:

- 1 Screening channel
- 2 Grit removal chamber, combined with fat and grease removal
- 3 Primary sedimentation tanks
- 4 Secondary sedimentation plant

BIOLOGICAL TREATMENT

see pages 30/31

The pretreated waste water will be aerated in biological tanks. By adding oxygen, a special bacteria will be created to reduce the biodegradable soluble organic contaminants in the waste water.

Construction elements:

- 5 Aerated and anoxic biological tanks

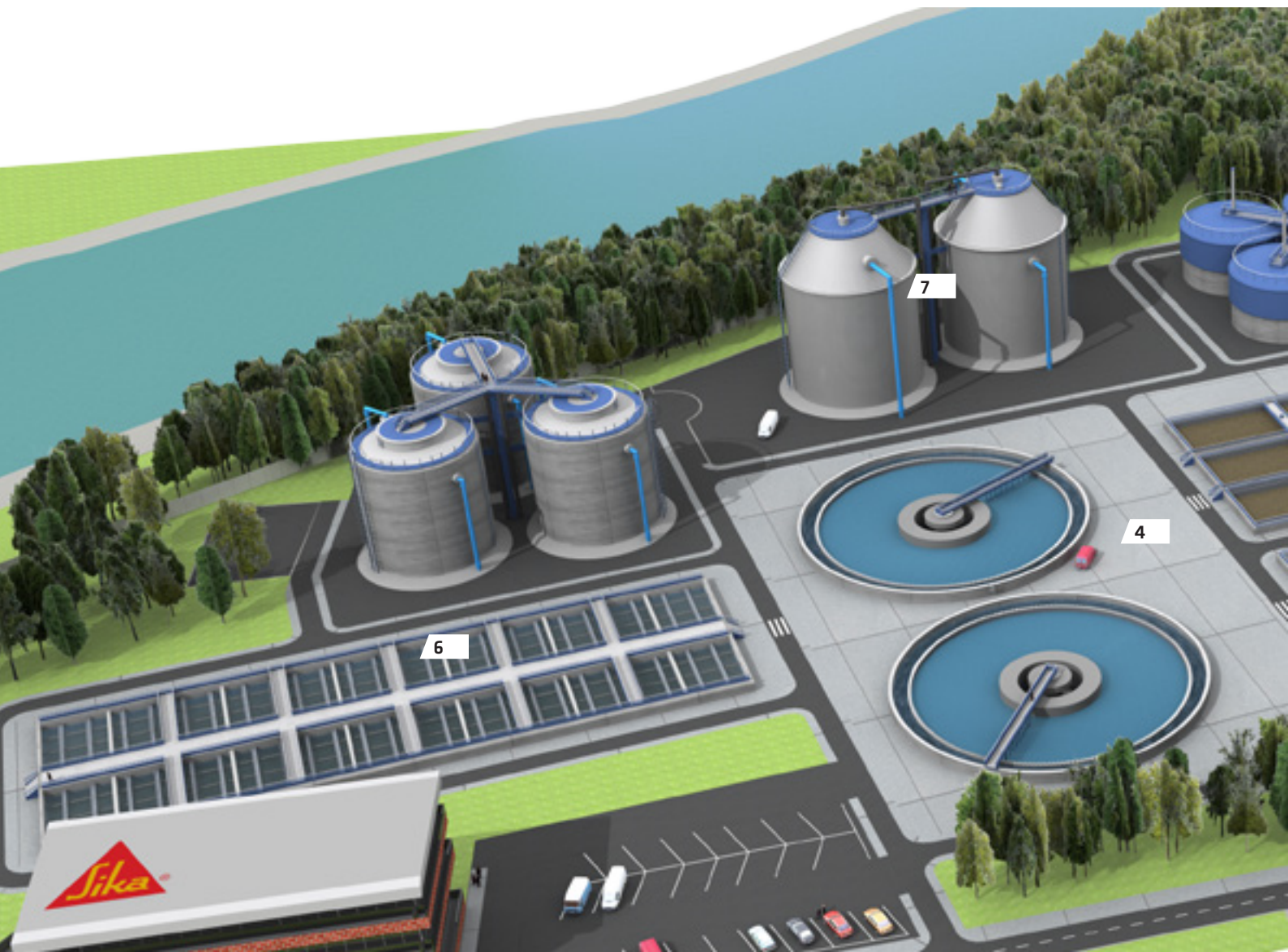

CHEMICAL TREATMENT

see pages 30/31

The aim of the chemical treatment is to remove phosphorus by adding special chemicals as ferric chloride. This results in a chemical flocculation that will be removed further in the filtration process.

Construction elements:

5 Aerated and anoxic biological tanks

FILTRATION

see pages 36/37

All the remaining particles after the biological and chemical treatment will be retained in special sand filter beds. The cleaned water is discharged to the receiving environment.

Construction elements:

6 Filtration beds

SLUDGE TREATMENT

see pages 32 to 35 and 40/41

Sludge from the primary and secondary sedimentation will be digested to reduce the amount of organic matter. Within this process, biogas (methane, CO₂) will be produced and stored in gasometers. Afterwards, the digested sludge will be dewatered first, before it will be disposed into an incinerator or landfill. In the energy building, methane gas will be used to produce electricity and heat.

Construction elements:

7 Digestion tanks

8 Gasometers

9 Energy building

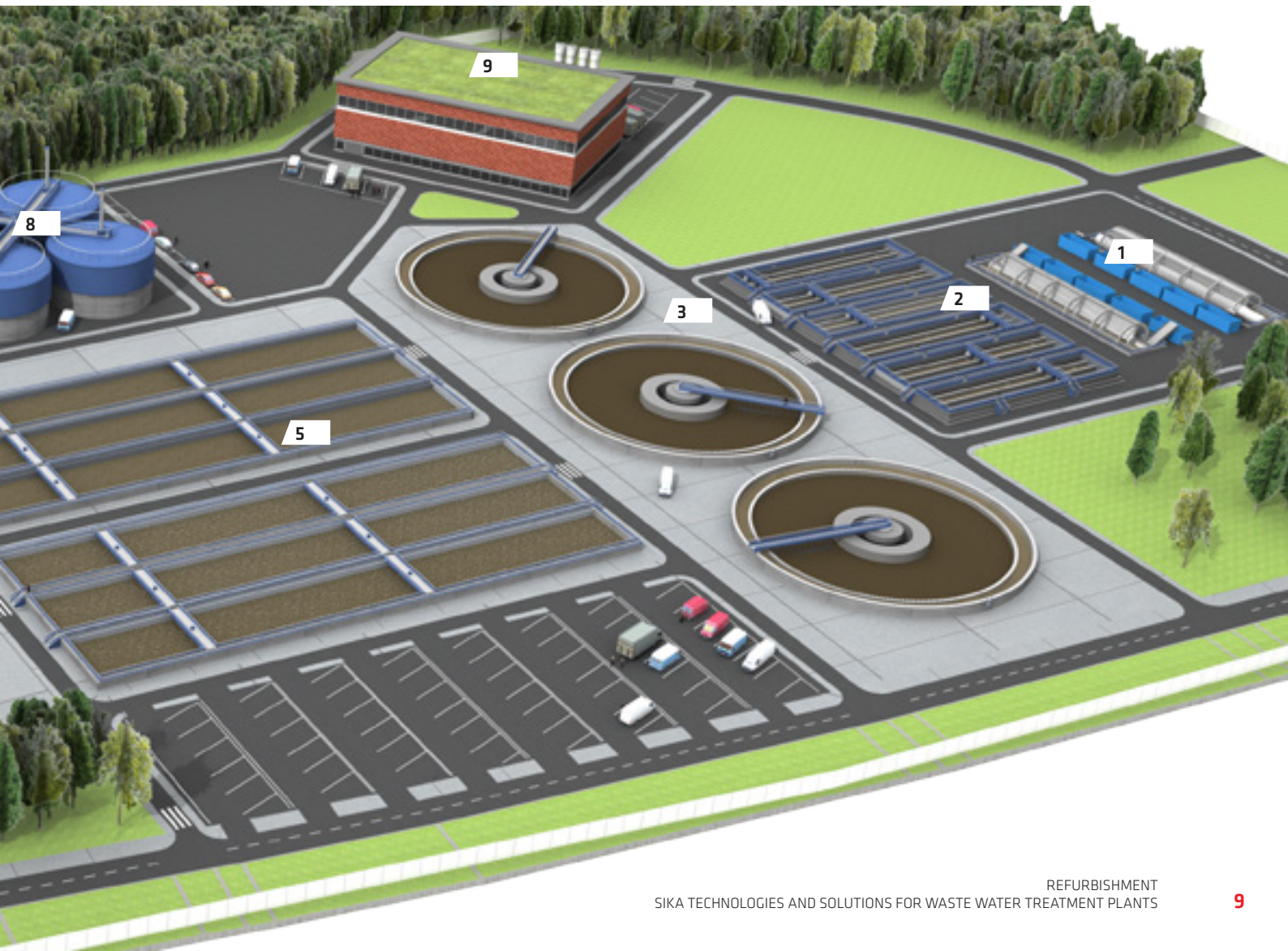

EXPOSURE FOR SEWERS

Most accessible sewers are more than 50 years old and in most cases are made of tamped or reinforced concrete in round, rectangular or ovoid shapes.

Generally, sewers present three different zones of stresses with specific issues:

A: Biogenic aggression, runoff, storm water, waste water or condensation

B: Runoff, storm and waste water, erosion and corrosion defects

C: Waste water, erosion and abrasion

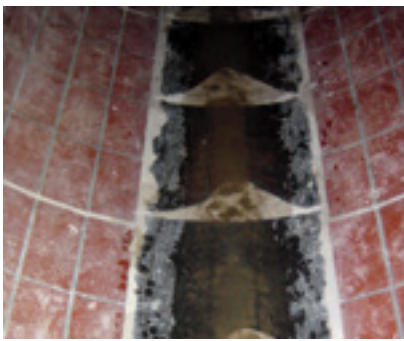
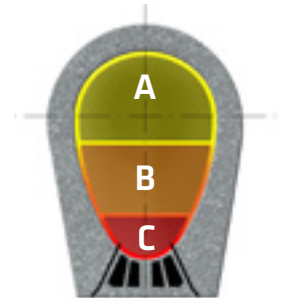

1 Damages at the bottom:

Heavy abrasion and erosion of the concrete and prefabricated elements are often found at the bottom of the sewers.

In general rules, these elements shall be replaced and reassembled properly by bonding them in place with an epoxy adhesive.



2 Localized defects of the concrete:

Lateral walls and the crown often show localized defects of the concrete and sometimes defects due to the corrosion of the reinforcement. After appropriate preparation, these defects can be repaired using sulfate resistant repair mortars.



3 Full degradation of the concrete surface:

The resistance of tamped concrete against a strong water current is generally not enough and often the full surface of the concrete is eroded. It is recommended in these zones to proceed with a full resurfacing.



4 Cracks with water leaks:

Due to shrinkage or settlements, concrete in sewers often cracks. These cracks need to be filled in order to prevent leakage of pollutant to surrounding ground water. It is often necessary to use expanding materials to fill these cracks.



5 Damages at the crown:

Exposed tamped concrete surfaces show very low resistance against carbonation and the aggressive substances contained in the waste water. Therefore, these surfaces can be protected using EpoCem® technologies which are extremely resis-



tant and watertight against urban waste water.

At the crown area, the structure can be protected against condensation water using a hydrophobic impregnation.



SIKA SOLUTIONS FOR SEWERS

The products and systems to repair sewers will vary according to the extent of damages, performance requirements, expected durability and budget. Sika can answer all the needs by offering products and system solutions to suit all requirements with the backup of worldwide references and experience.



REPAIR WORK

Sika MonoTop®-910 N

1-component anticorrosion slurry and bonding primer (when relevant)

Sika MonoTop®-412 NFG

1-component, polymer modified, sulphate resistant repair mortar

Sika® Abraroc® SR

1-component, hydraulic abrasion resistant repair mortar, hand or dry spray applied



SURFACE PROTECTION

Sikagard®-720 EpoCem®

Epoxy cement resurfacing mortar with high resistance against urban waste water

Sikagard®-740 W/-706 Thixo

Hydrophobic impregnation to protect the concrete crown against condensed water

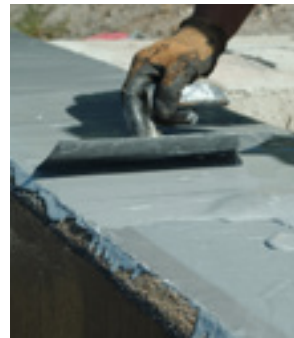

ADHESIVE / ANCHORING / CRACK TREATMENT

Adhesive

Sikadur®-31

Epoxy adhesive with high bonding on various substrate

Anchoring

SikaGrout®-311/-314

Fluid mortar for anchoring or grouting of elements

Crack treatment

Sikadur-Combiflex® SG System

High performance joint and crack waterproofing system made of a FPO tape and epoxy adhesive

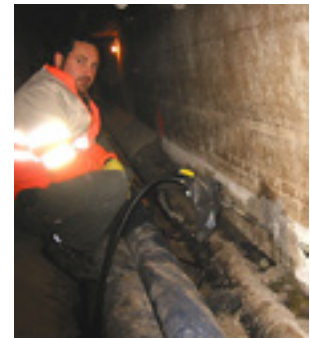

INJECTIONS / FILLING

Sika® Injection-105 RC

2-component expanding polyurethane foam to stop water leakage and temporary watertightness of cracks to allow further permanent injection

Sika® Injection-201 CE

2-component, elastic PUR resin for permanent and durable filling of the cracks, complying with EN 1504-5 as crack filling material for concrete (U(D1) W(2) (1/2/3) (9/30))

Sikadur®-52

2-component, fluid epoxy resin for structural injection of the cracks

Sika® InjectoCem-190

2-component, micro-cement injection

FILLING (FLOOR)

SikaFix®-HS

Fast reacting, 2-component hybrid (organic and mineral) resin to fill cavities



PROBLEMS AND DAMAGES TO STRUCTURES

SCREENING CHANNELS

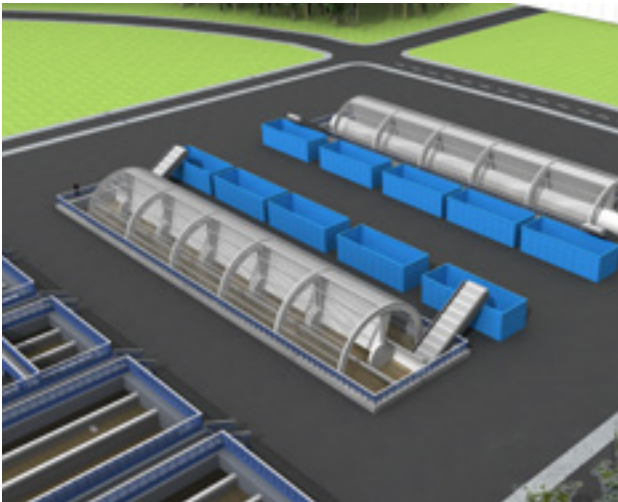

- Abrasion and erosion due to sand, grit or other heavy particles
- Chemical attacks due to aggressive waste or industrial water
- Leakage due to cracks, untight joints or damaged concrete

GRIT, FAT & GREASE CHAMBERS

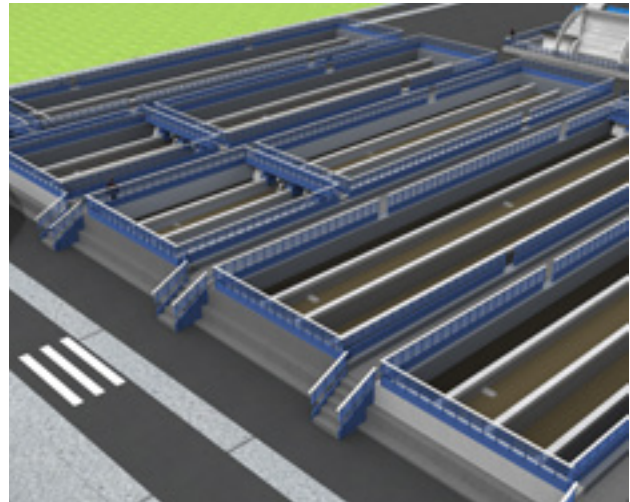

- Abrasion and erosion due to sand, grit or other heavy particles
- Chemical attacks due to aggressive waste or industrial water
- Leakage due to cracks, untight joints or damaged concrete

GASOMETERS



- Steel corrosion
- Untight joints
- Sulfuric acid damages

DIGESTION TANKS



- Concrete damage due to sulfuric acid
- Leakage due to damaged waterproofing
- Cracks due to thermal expansion or shrinkage

PRIMARY SEDIMENTATION TANKS

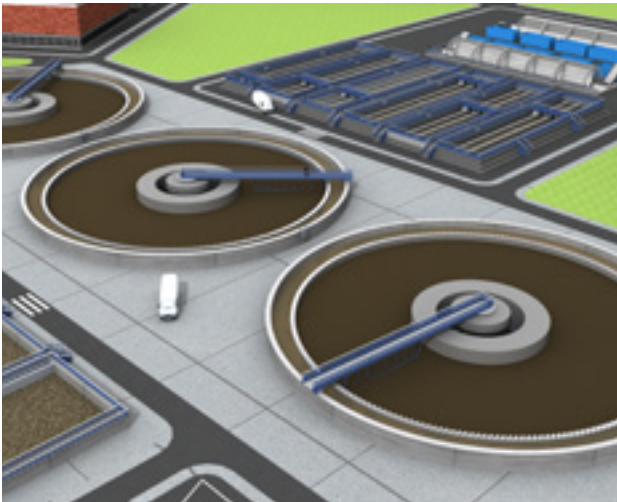

- Chemical attacks due to aggressive waste or industrial water
- Leakage due to improper waterproofing
- Cracks due to thermal expansion or shrinkage
- Steel reinforcement corrosion due to low concrete cover
- Mechanical abrasion at the rolling pad

BIOLOGICAL TANKS

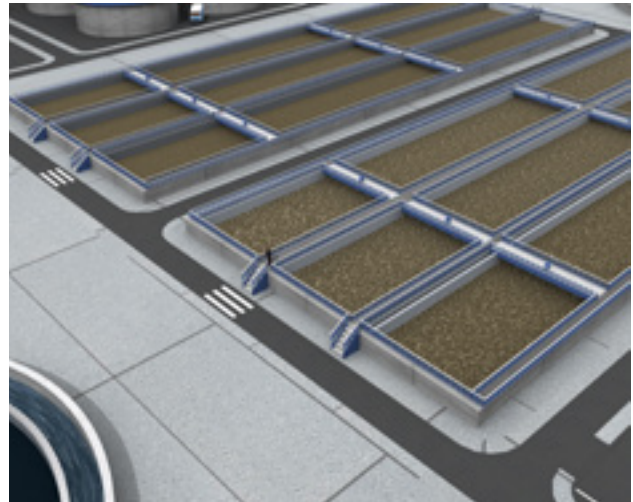

- Erosion due to water flow
- Chemical attacks due to aggressive waste or industrial water
- Leakage due to damaged waterproofing
- Cracks due to thermal expansion or shrinkage
- Steel reinforcement corrosion due to low concrete cover

FILTRATION BEDS

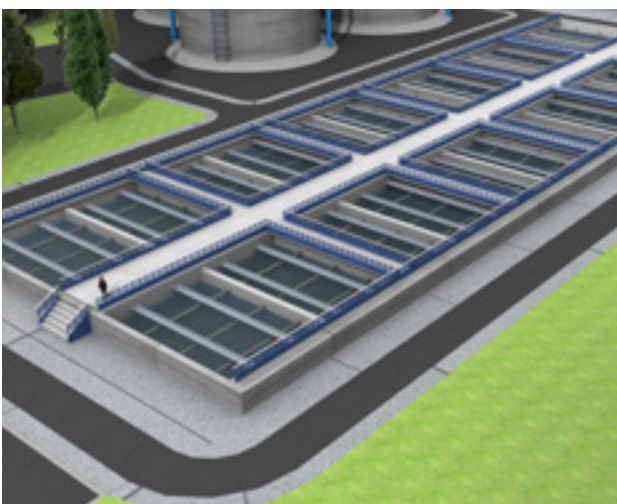

- Abrasion due to sand
- Leakage due to damaged waterproofing
- Cracks due to thermal expansion or shrinkage

SECONDARY SEDIMENTATION TANKS

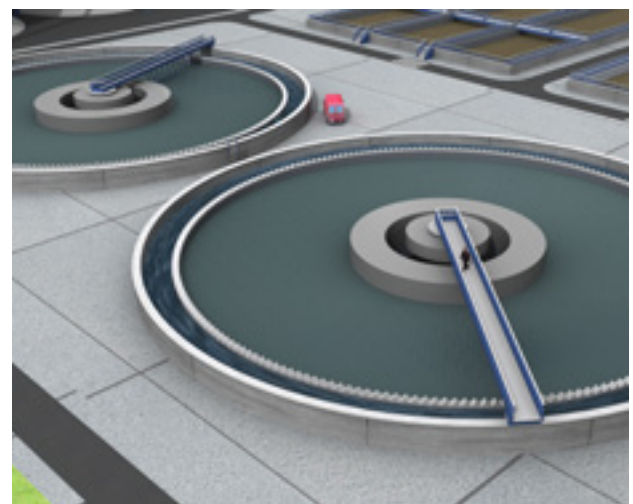

- Leakage due to damaged waterproofing
- Cracks due to thermal expansion or shrinkage
- Mechanical abrasion at the rolling pad

AGGRESSIVE SUBSTANCES IN SEWAGE – SUSTAINED ATTACK ON CONCRETE

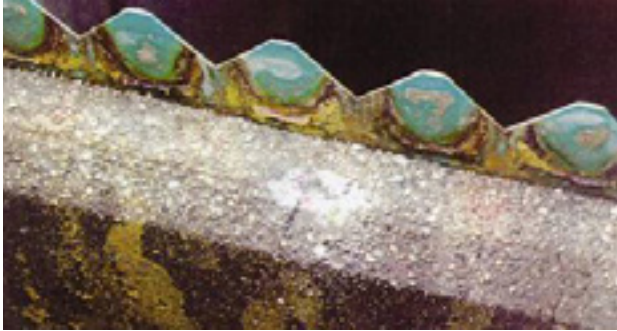

The type and extent of concrete damage to be expected in all areas of sewerage systems, is determined by the corrosiveness of the substances present, by the quality of the existing concrete and by the quality of any protective treatments. The level of concrete corrosiveness in the different parts of the sewerage system exposed to waste water can be assessed on the basis of EN 206: 2013. This European standard defines three levels of chemical attack (XA1, XA2 and XA3 – low, severe and very severe respectively) on concrete. By reference to the pH value, this is useful for rain water and ground water – but not always sufficient for sewage due to other factors such as Biogenic Sulfuric Acid corrosion (BSA – see further). The status of the water quality under this standard is however still an essential basis for selecting and applying suitable repair systems, all other relevant factors provided, such as BSA are also carefully considered. The repair system selection is of course also made on the basis of the concrete quality and in terms of the depth of damage, chloride levels and substrate strength etc. For very serious chemical attack, additional treatment in the form of a surface protection system is required, over and above the concrete repair and replacement. This so-called Biogenic Sulfuric Acid corrosion (BSA) is usually the most serious cause of damage to the interior of biogas tanks. Sulfuric and sulfurous acids can cause concrete erosion rates of 0.5 – 10.00 mm per annum; in extreme cases erosion of up to 20 mm has been measured. It is clear that as a result of these chemical processes involved in biogas generation, safe, effective and durable protective measures for the steel and concrete surfaces are required.

BIOGENIC SULFURIC ACID CORROSION

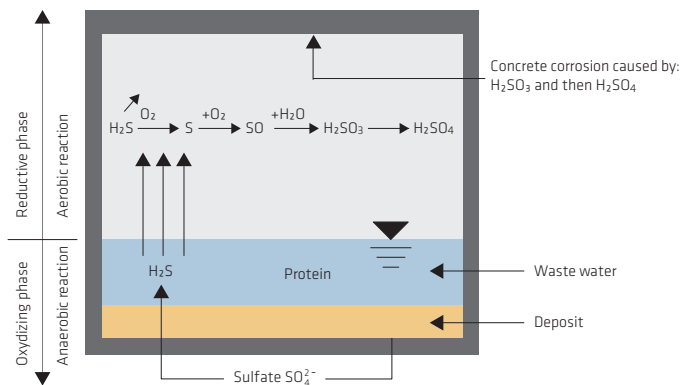

Danger in delay – Biogenic Sulfuric Acid corrosion (BSA)

The chemical composition of biogas consists mainly of methane and variable concentrations of carbon dioxide, water vapour, hydrogen sulfide, nitrogen, oxygen and hydrogen. The proteins present in the fermenters break down into amino acids. These amino acids and the sulfates present form, among other things, hydrogen sulfide (H_2S). This moves to the gas compartment by diffusion, where it is oxidized and condenses on the walls and soffits as elementary sulfur deposits. The sulfur is then used as an energy source by thiobacteria and is thereby converted primarily to sulfurous (H_2SO_3) and then to sulfuric acid (H_2SO_4). This “biogenically” formed sulfuric acid aggressively corrodes metal components and severely attacks concrete, destroying it progressively from the inside.

Limiting values for exposure classes for chemical attack from ground water as per EN 206: 2013

Chemical characteristics	Test methods	XA1	XA2	XA3
Sulfate (SO_4^{2-}) in mg/l	EN 196-2	≥ 200 and ≤ 600	> 600 and ≤ 3000	> 3000 and ≤ 6000
pH	ISO 4316	≤ 6.5 and ≥ 5.5	< 5.5 and ≥ 4.5	< 4.5 and ≥ 4.0
Aggressive CO_2	EN 13577	≥ 15 and ≤ 40	> 40 and ≤ 100	> 100 to saturation
Ammonium (NH_4^+) in mg/l	ISO 7150-1 or ISO 7150-2	≥ 15 and ≤ 30	> 30 and ≤ 60	> 60 and ≤ 100
Magnesium (Mg^{2+}) in mg/l	ISO 7980	≥ 300 and ≤ 1000	> 1000 and ≤ 3000	> 3000 to saturation



SIKA'S FIELD EXPERIENCE SINCE 1991

Results of Experimental Testing of Protection Systems in an Aeration Tank

In 1991, in one of the largest sewage treatment plants in Europe, different coating systems were applied in an aeration tank and left in real life exposure. Investigations were carried out at various time intervals to assess the longterm performances of the installed coating systems.

Note: Full article available upon request

LIFE EXPECTANCY IN AERATION TANKS

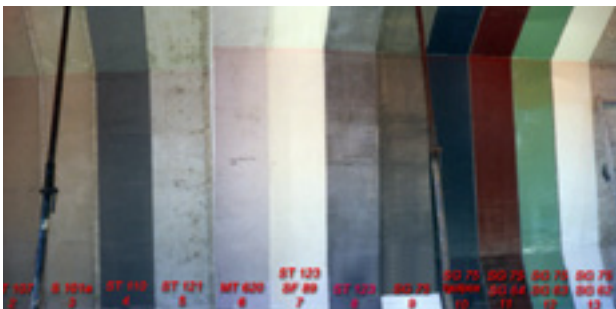
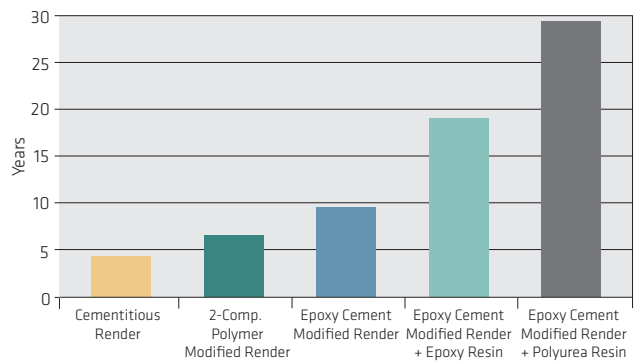

View of the various systems right after application in September 1991



Overview of the test areas in 2008

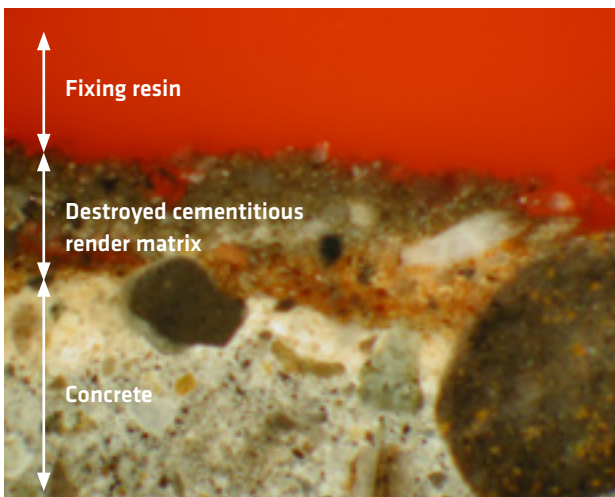

Cementitious mortars:

Because the sewage dissolves the cement paste, continuous erosion begins within a short period of time. The binder matrix is weakened and the aggregates then break away.

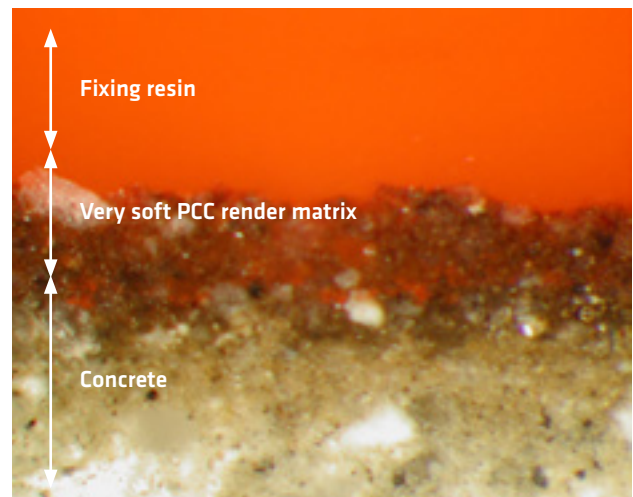

Polymer modified cementitious mortars:

They have a longer durability than normal cementitious mortars. However, when subject to aggressive chemical environments, their resistance is significantly reduced. When not over-coated, they can only provide protection for a short term.

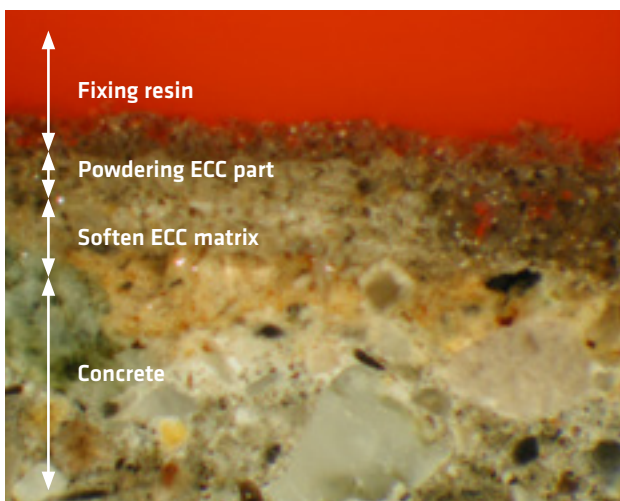

Epoxy cement mortar:

The epoxy resin component improves the chemical resistance of the cement matrix. But due to the level of aggressiveness in waste treatment plant, they can only provide protection for a medium term.

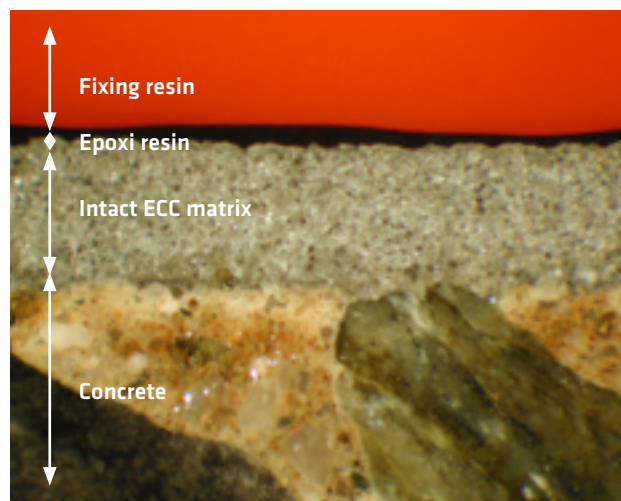

Resin coatings:

According to their formulations, resin coatings (epoxy or polyurea) can bring long-term durability. However, particular attention must be paid to prevent osmotic blister by the use of EpoCem® levelling mortar as pre-treatment. Sikagard®-720 EpoCem® does not require curing and allows for a fast over-coating with a reactive resin. This allows a quicker and safer application process than normal cement render.

GENERAL SEWAGE TREATMENT PLANT REFURBISHMENT CONSIDERATIONS

Before defining the repair and protection strategy, the specific sewage treatment plant requirements on refurbishment must be considered. These requirements can have an important influence in determining the correct design, planning and construction procedures, together with the future maintenance works necessary for the sewage treatment plant.

Examples of these project related requirements are outlined below.

DURABILITY

Remedial works on a sewage water treatment plant can cause substantial costs; hence the frequency of remediation work should be as low as possible. Therefore, products used in these remedial works must provide adequate durability to extend the defined functional service life.

DURATION OF CLOSURE / DOWN TIME

During the time of remedial works, either the plant is completely or partly shut down leading to extra demand on neighboring plants. The remedial works selected shall minimize this duration of closure.

SYSTEM COMPATIBILITY

Remedial works on complex large sewage water treatment plants often demand a complete and integrated system build-up. The compatibility of products and system is very important. The use of one full range system supplier with proven compatible products and systems ensures this is achieved.

TOTAL LIFE CYCLE COSTING

The total costs must take into account the actual costs of the remedial works plus the maintenance costs of the defined functional service life.

This significantly influences the selection of the appropriate refurbishment concept and the specific materials to be used.

EXPOSURES / SITE CONDITIONS

The specific site exposure and environmental conditions, such as the climate, access and space for material application, also significantly influences the selection of the refurbishment concept, the appropriate materials and application techniques.

ECOLOGY

Environmental friendly and sustainable materials such as solvent free products help to safeguard the environment. These are increasingly an important requirement. In some countries, some financial penalties are being imposed to contractors that use products that release Volatile Organic Compounds (VOC's).



GENERAL SEWAGE TREATMENT PLANT REFURBISHMENT PROCEDURES

The repair and protection of sewage treatment plants must always be executed according to all relevant local standards and regulations. After a detailed condition survey and root cause analysis, the right procedures for successful refurbishment can be defined.

Standards (such as European Standard EN 1504-9) define principles and methods to refurbish damaged concrete. Please refer to our Brochure "The Repair and Protection of Reinforced Concrete with Sika" for more information relating to repair and protection according to EN 1504-9.

Types of Damage/Defects (Examples)		Possible Principles/Methods EN 1504-9	
		For the Repair	For the Protection
Concrete spalling/scaling of concrete surface		Principle 3: Concrete restoration (Method 3.1/3.2/3.3)	Principle 1: Protection against ingress (Methods 1.1/1.2/1.3) Principle 5: Physical resistance (Method 5.1/5.2/5.3)
Steel reinforcement corrosion		Principle 7: Restoring passivity (Method 7.1/7.2)	Principle 8: Increasing resistivity (Method 8.1/8.2/8.3) Principle 9: Cathodic control (Method 9.1) Principle 10: Cathodic protection (Method 10.1) Control of anodic areas (Methods 11.1/11.2/11.3)
Structural cracks		Principle 4: Crack injection (Method 4.5/4.6)	Principle 4: Structural strengthening (Methods 4.1/4.3/4.4/4.7)
Non-structural cracks		Principle 1: Filling of cracks (Method 1.5)	Principle 1: Protection against ingress (Method 1.1/1.2/1.3) Principle 2: Moisture control (Method 2.1/2.2/2.3) Principle 5: Physical resistance (Methods 5.1/5.2/5.3)
Chemical attacks		Principle 6: Adding mortar or concrete (Method 6.3)	Principle 6: Resistance to chemicals with coating (Method 6.1)
Structural and non-structural steel corrosion		Not applicable	ISO 12944 Refers to the corrosion protection of steel structures

OVERVIEW OF SIKA SOLUTIONS FOR EACH STRUCTURE

SCREENING CHANNELS

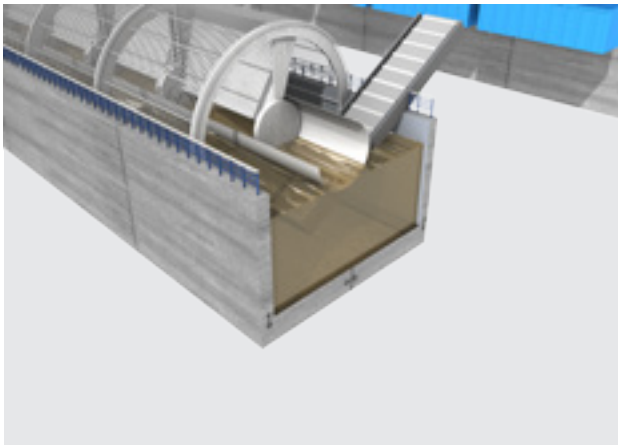

- Abrasion and erosion:
Sika® Abraroc® SR
- Chemical attacks:
Sikagard®-720 EpoCem® + Sika® Poxitar F (or Sikagard®-63 N)
- Cracks, untight joints:
Sikadur-Combiflex® SG or Sikaflex® Pro-3

GRIT, FAT & GREASE CHAMBERS

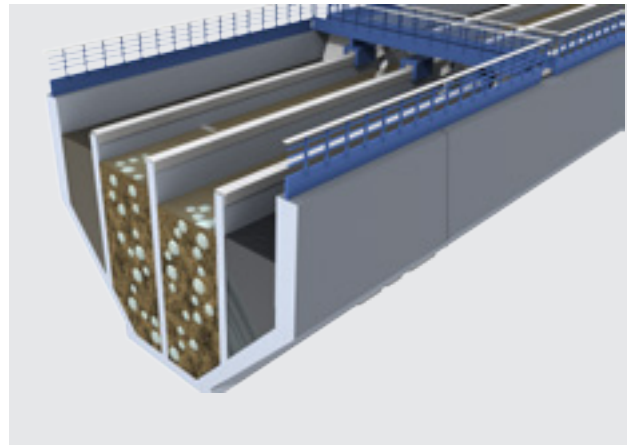

- Abrasion and erosion:
Sika® Abraroc® SR
- Chemical attacks:
Sikagard®-720 EpoCem® + Sika® Poxitar F (or Sikagard®-63 N)
- Cracks, untight joints:
Sikadur-Combiflex® SG or Sikaflex® Pro-3

GASOMETERS

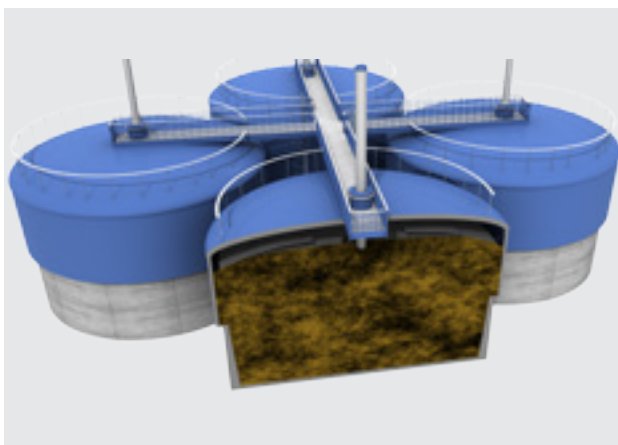

- Steel corrosion:
Sika® Icosit® 6630 System or SikaCor® EG System
- Steel joint:
Sikaflex® TS Plus
- Sulfuric acid attack:
Sika® Permacor® 3326 EG H or Sikalastic®-844 XT

DIGESTION TANKS

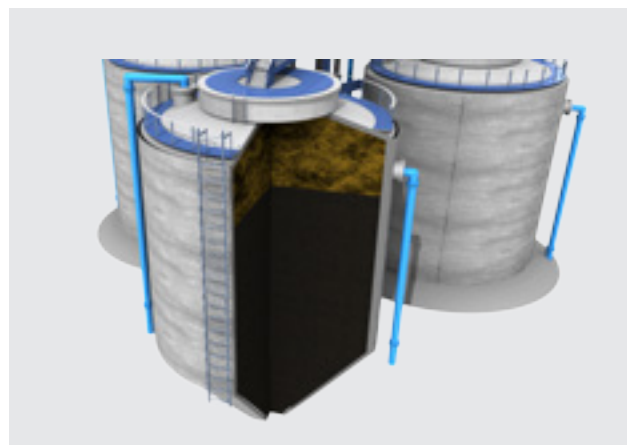

- Sulfuric acid attack and waterproofing:
Sika® Permacor® 3326 EG H
or Sikalastic®-844 XT
- Cracks:
Sikadur-Combiflex® SG
- Chemical resistant joint:
Sikaflex® Pro-3

PRIMARY SEDIMENTATION TANKS

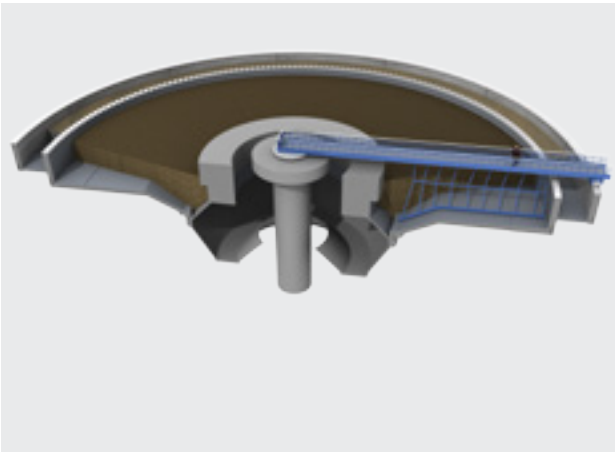

- Chemical attacks and damaged waterproofing:
Sikagard®-720 EpoCem® + Sika® Poxitar F (or Sikagard®-63 N)
- Cracks, untight joints:
Sikadur-Combiflex® SG or Sikaflex® Pro-3
- Damaged concrete and steel reinforcement corrosion:
Sika MonoTop®-412 NFG, SikaTop® Armatec®-110 EpoCem®
- Mechanical abrasion:
Sikadur®-42 or Sika® Icosit®-KC 330 FK

BIOLOGICAL TANKS

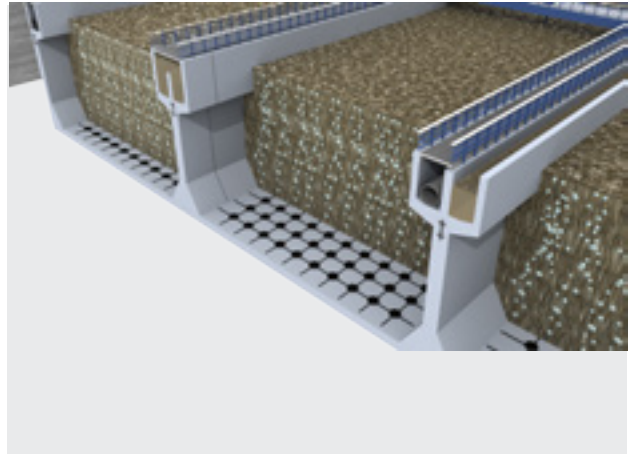

- Chemical attacks and damaged waterproofing:
Sikagard®-720 EpoCem® + Sika® Poxitar F (or Sikagard®-63 N)
- Cracks, untight joints:
Sikadur-Combiflex® SG or Sikaflex® Pro-3
- Damaged concrete and steel reinforcement corrosion:
Sika MonoTop®-412 NFG, SikaTop® Armatec®-110 EpoCem®

FILTRATION BEDS

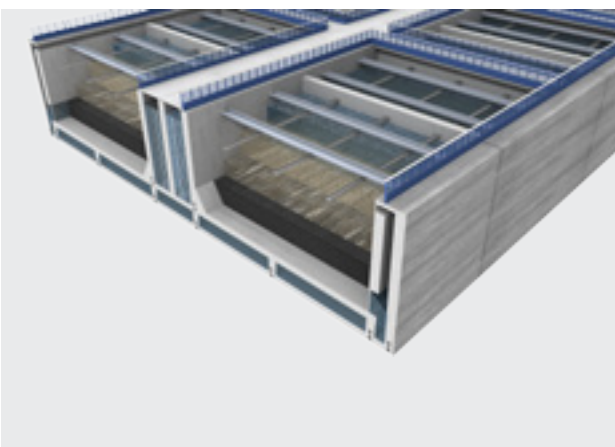

- Abrasion:
Sika® Abraroc® SR
- Damaged waterproofing:
Sikagard®-720 EpoCem®
- Cracks:
Sikadur-Combiflex® SG or Sikaflex® Pro-3

SECONDARY SEDIMENTATION TANKS

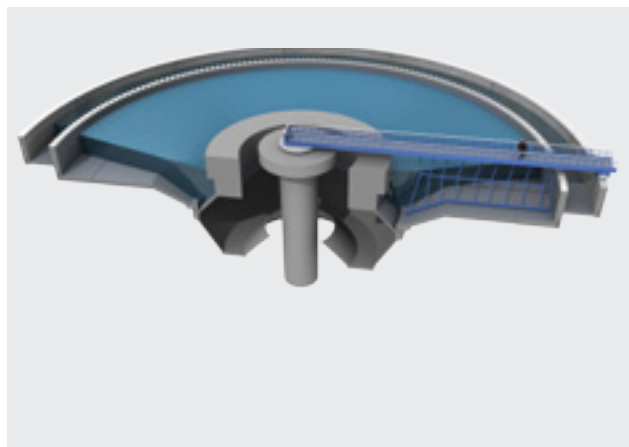

- Damaged waterproofing:
Sikagard®-720 EpoCem®
- Cracks:
Sikadur-Combiflex® SG or Sikaflex® Pro-3

SIKA SOLUTIONS FOR SCREENING CHANNELS

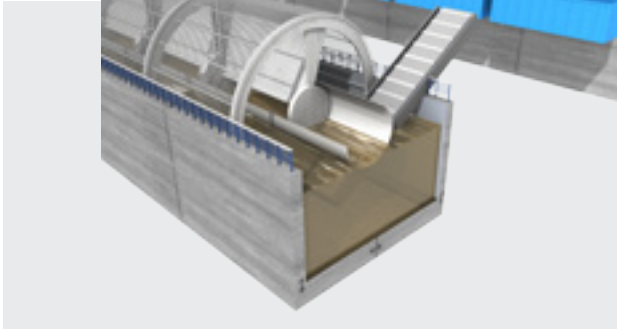

GENERAL DESCRIPTION & MAIN REQUIREMENTS

In a large treatment plant, the removal of large objects is automatically performed in the screening channel.

Typical problems encountered are:

- Abrasion and erosion due to sand, grit or other particles.
- Chemical attacks, depending on the aggressiveness of the waste or industrial water.
- Leakage and risk of pollution due to cracks, untight joints or damaged concrete.

SIKA SOLUTIONS FOR HYDRAULIC ABRASION

In waste water treatment plants, erosion is mainly due to abrasion or by chemical attack.

Erosion damage results from the abrasive effect of water-borne silt, sand, gravel, and other debris being circulated over a concrete surface during operation.

The compounds present in hardened Portland cement are attacked by the aggressiveness (low pH) of the waste water. Sika is specialized in this field since decades and, together with major partners, has developed products that address the issues above:

Sika® Abraroc® SR:

- Hydraulic abrasion resistant mortar
- Sulfate resistant
- Mild acid resistant
- Spray applied





TYPICAL DETAIL

- 1 Host concrete
- 2 Abraded surface
- 3 Over laying with Sika® Abraroc® SR

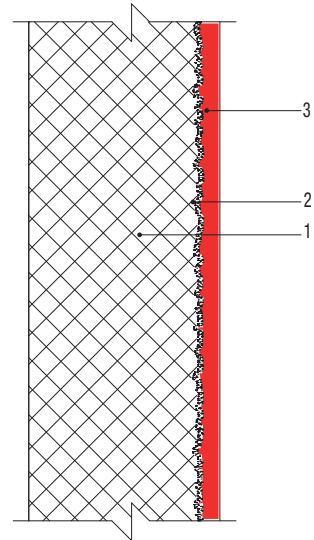

OTHER TYPICAL PROBLEMS AND SIKA SOLUTIONS:

- Chemical attacks:
Sikagard®-720 EpoCem® and Sika® Poxitar F (or Sikagard®-63 N)
- Cracks, untight joints:
Sikadur-Combiflex® SG or Sikaflex® Pro-3
- Damaged concrete and steel reinforcement corrosion:
Sika MonoTop®-412 NFG
SikaTop® Armatec®-110 EpoCem®



SIKA SOLUTIONS FOR GRIT, FAT AND GREASE CHAMBERS

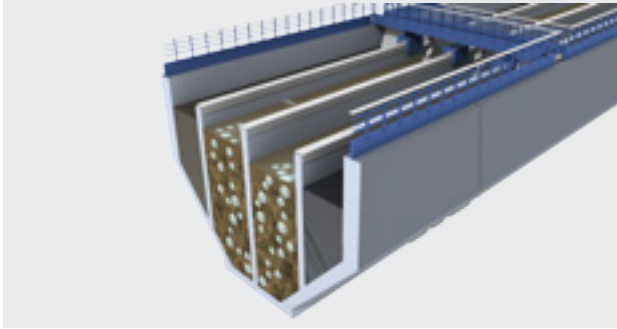

GENERAL DESCRIPTION & MAIN REQUIREMENTS

In some plants, pre-treatment may include a grit channel where the waste water velocity is adjusted to allow settlement of the sands/grits or other hard particles. Sands/grits must be removed as they may damage pumps or other equipments. Fat and grease removal is generally done in large plant in the primary settlement tank using mechanical surface skimmers.

Typical problems encountered are:

- Abrasion and erosion due to sand, grit or other particles.
- Chemical attacks depending on the aggressiveness of the waste or industrial water.
- Leakage and risk of pollution due to cracks, untight joints or damaged concrete.

SIKA SOLUTIONS FOR UNTIGHT JOINTS

Very often in waste water treatment, joints sealed with average sealant fail due to the lack of chemical resistance of these products. Instead of proceeding to the full removal of the failed joint, Sika has developed joint system that can be applied over the original failed material.

The Sikadur-Combiflex® SG system is the second generation development of the globally proven Sikadur-Combiflex® with even improved performance such as advanced adhesion properties. The unique system consists of the Sikadur-Combiflex® SG tape and the Sikadur® adhesives. It is widely used as joint waterproofing in watertight concrete structures.

Advantages:

- Repair of failed joint
- Blocking the path of water penetration
- Increased length of water penetration
- Fully bonded to the concrete preventing underflow
- Waterproofing of joints with extreme movements
- Easy to install and adjust to complicated construction details
- Excellent adhesion to different substrates
- Resistant to high water pressure
- Crack sealing system
- Easy to control and repair





TYPICAL DETAIL

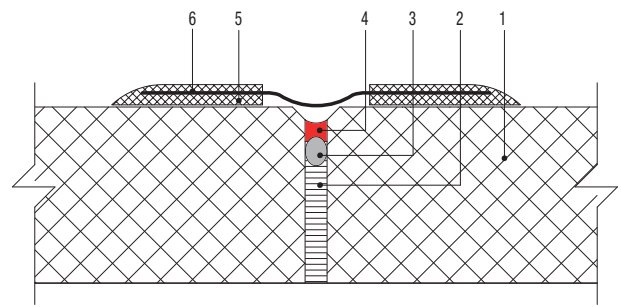

- | | |
|--------------------------------|------------------------------|
| 1 Substrate | 4 Failed sealant |
| 2 Existing compression profile | 5 Sikadur® adhesive |
| 3 Existing backing rod | 6 Sikadur-Combiflex® SG Tape |

OTHER TYPICAL PROBLEMS AND SIKA SOLUTIONS:

- Abrasion and erosion:
Sika® Abraroc®
- Chemical attacks (fatty acid):
Sikagard®-720 EpoCem® and Sikagard®-63 N
- Damaged concrete and steel reinforcement corrosion:
Sika MonoTop®-412 NFG
SikaTop® Armatec®-110 EpoCem®



SIKA SOLUTIONS FOR SCREENING PRIMARY SEDIMENTATION TANKS

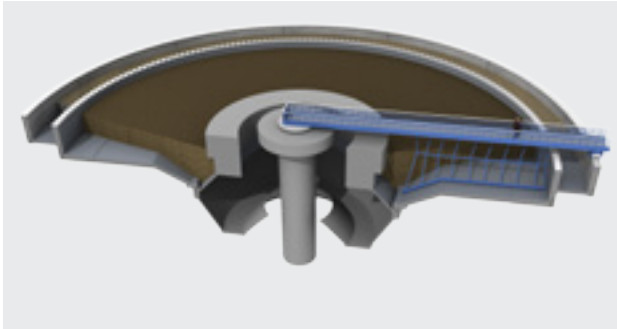

GENERAL DESCRIPTION & MAIN REQUIREMENTS

In the primary sedimentation tank, sewage flows through large tanks, commonly named “primary clarifiers” or “primary sedimentation tanks”. These tanks are equipped with mechanically driven scrapers that drive the collected sludge towards a hopper.

Typical problems encountered in these tanks are:

- Abrasion and erosion due to sand, grit or other particles.
- Heavy abrasion on the rolling pad of the scrapper.
- Chemical attacks depending on the aggressiveness of the waste or industrial water.
- Leakage and risk of pollution due to cracks, untight joints or damaged concrete.

SIKA SOLUTIONS FOR ABRASION RESISTANT GROUT

Mechanical scrapper movement yields to heavy stress combining vibration and abrasion.

Although cost effective, cement based products do not resist much against stress from vibration of the scrapper and therefore do not last long.

Sika proposes for this usage either epoxy or PU based grout / adhesive to fix the metallic rolling cladding on the running surface of the scrapper

Sikadur®-42 HE

- 3-pack epoxy grout
- High early strength and fast curing
- Stress and impact resistant
- High vibration resistance

Sika® Icosit® KC 330 FK

- 2-pack, solvent-free polyurethane adhesive
- High initial adhesion
- Vibration reducing
- Noise absorbing
- Not requiring temporary fixation





TYPICAL DETAIL

- 1 Concrete wall of clarifier
- 2 Ground level
- 3 Water level within the clarifier
- 4 V2A Stainless steel plate
- 5 Priming of concrete surface with Primer such as Sika® Icosit® KC 330 Primer or equivalent
- 6 Shock absorbing, vibration damping & bonding material such as Sika® Icosit® KC 330 FK
- 7 Priming after grinding the under side of the stainless steel plate with primer such as Sika® Icosit® KC Primer or equivalent
- 8 Scraper bridge

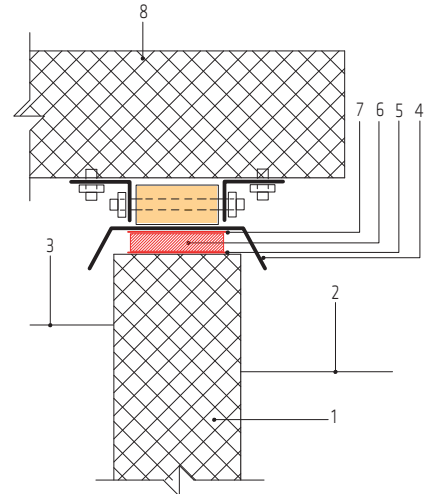

OTHER TYPICAL PROBLEMS AND SIKA SOLUTIONS:

- Chemical attacks and improper waterproofing:
Sikagard®-720 EpoCem® and Sika® Poxitar F (or Sikagard®-63 N)
- Cracks, untight joints:
Sikadur-Combiflex® SG or Sikaflex® Pro-3
- Damaged concrete and steel reinforcement corrosion:
Sika MonoTop®-412 NFG
SikaTop® Armatec®-110 EpoCem®
- External concrete protection:
Sikagard®-740 W hydrophobic impregnation
Sikagard®-675 W ElastoColor protective coating



SIKA SOLUTIONS FOR BIOLOGICAL TANKS

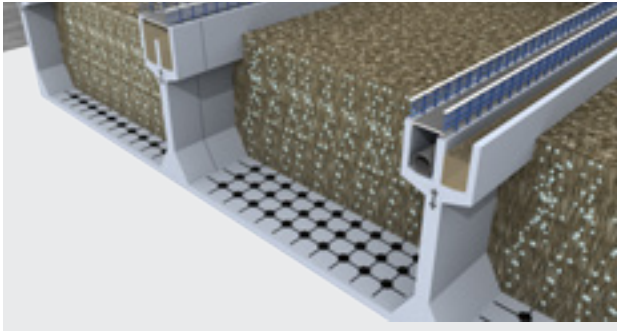

GENERAL DESCRIPTION & MAIN REQUIREMENTS

Primary sedimentation tanks are designed to substantially degrade the biological content of the sewage. These biological contents are originated from human waste, soap and detergents.

Typical problems encountered in these tanks are:

- Chemical attacks depending on the aggressiveness of the waste or industrial water.
- Leakage and risk of pollution due to cracks, untight joints or bad quality concrete.
- Concrete spalling due to reinforcement steel corrosion.

SIKA SOLUTIONS FOR CONCRETE REPAIR

Overview

Repairing damaged concrete is one of the primary requirements in the maintenance of sewage treatment plants. A sound and correctly repaired concrete substrate is also the basic requirement for any additional waterproofing, protection or strengthening systems to be applied.

Requirements

- Full system compatibility (bonding primer, repair mortar, levelling mortar)
- Approved for structural repairs where required (e.g. class R3 or R4 according to EN 1504-3)
- Low crack sensitivity
- Fast and easy application

SIKA SOLUTIONS

- Bonding primer for large area repairs (where relevant): SikaTop® Armatex®-110 EpoCem®
- Reinforcement steel bar corrosion protection: SikaTop® Armatex®-110 EpoCem®
- Semi-fluid repair mortars for large area repairs: Sika MonoTop®-432 N
- Thixotropic repair mortars for local patch repairs: Sika MonoTop®-412 N / NFG
- Surface levelling and fairing mortars: Sika MonoTop®-723 N (normal performance) or Sikagard®-720 EpoCem® (high performance)



- Self-levelling, epoxy modified, cement based levelling mortars: Sikafloor®-81/-82 EpoCem®
- Highly resistant to hydraulic abrasion cement based mortar: Sika® Abraroc® SR

Sika concrete repair expertise

Sika provides an extensive range of thoroughly tested and proven repair materials and systems based on different technologies for each specific requirement and situation.



TYPICAL DETAIL

- 1 Host sound concrete
- 2 Cutting line of damaged concrete, cleaned and prepared substrate
- 3 Bonding primer (if relevant/required: e.g. SikaTop® Armatec®-110 EpoCem®)
- 4 Corrosion protective coat (e.g. SikaTop® Armatec®-110 EpoCem®)
- 5 Repair mortar (e.g. Sika MonoTop®-412 NFG)
- 6 Smoothing coat (e.g. Sika MonoTop®-723 N)

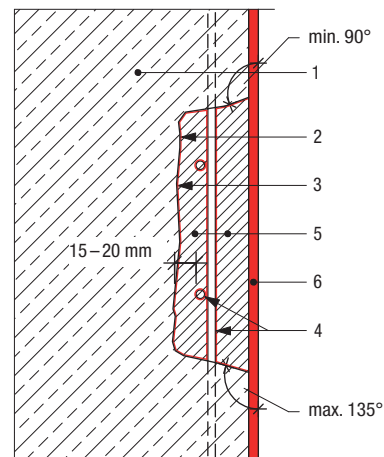

OTHER TYPICAL PROBLEMS AND SIKA SOLUTIONS:

- Chemical attacks and damaged waterproofing: Sikagard®-720 EpoCem® and Sika® Poxitar F or Sikagard®-63 N
- Cracks, untight joints: Sikadur-Combiflex® SG, Sikaflex® Pro-3
- External concrete protection: Sikagard®-740 W hydrophobic impregnation Sikagard®-675 W ElastoColor protective coating



SIKA SOLUTIONS FOR GASOMETER

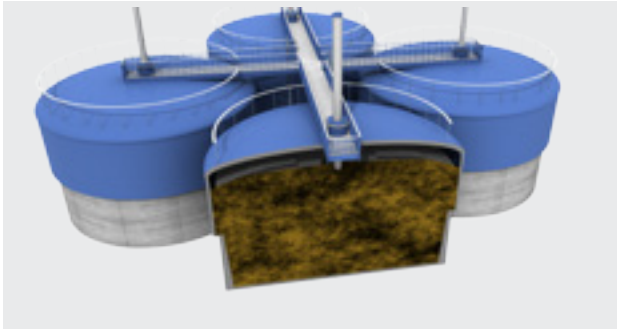

General Description & Main Requirements

Within the process of biological deterioration in the biological tank or the digestion tank, biogas (methane, CO₂) will be produced and be stored in gasometers. These gasometers are generally built in steel. Biogenic sulfuric acid is highly aggressive to steel. Additional stresses are caused by the elevated temperature.

Typical problems encountered are:

- Steel corrosion
- Leakage and risk of pollution due to untight joints

SIKA SOLUTIONS FOR STEEL CORROSION

Sika provides a large range of extensively tested products in the field of corrosion protection. Sika offers products for the protection of new structures on site or for shop application. For maintenance works, Sika offers a surface tolerant primer allowing application of the corrosion protection without sand-blasting the surface, meaning no plant shut down is necessary. UV-resistant top coats, available in almost all RAL color shades, give the possibility for aesthetic designs.

SIKA SOLUTIONS FOR DIGESTERS, GASOMETER AND BSA (BIOGENIC SULPHURIC ACID) CORROSION OF STEEL STRUCTURES

- Hot spray Polyurea, solvent free, crack bridging, highest chemical resistance, 1 layer application:
Sikalastic®-844 XT, on primer SikaCor® EG 1 (on steel)
- High performance epoxy resin, solvent based, 3 layer application:
Sika Permacor®-3326 EG H, directly applied on blasted steel

SIKA SOLUTIONS FOR STEEL COMPONENTS

- Steel, not subject to BSA:
- Standard epoxy, solvent free, high chemical resistance, 3 layer application Sikagard®-63 N
- Epoxy, anthracene oil based, high solid Sika® Poxitar F



SIKA SOLUTIONS FOR STRUCTURAL STEEL WORK

Coating systems for structural steel have to fulfil the requirements in accordance to EN ISO 12944:

- System build-up for corrosive industrial and maritime climate based on 2-comp. products SikaCor® EG-System
- System build-up for maintenance: Sika® Poxicolor Primer HE



TYPICAL DETAIL

- 1 Steel plates
- 2 Bolt with protection
- 3 Sikaflex® TS Plus

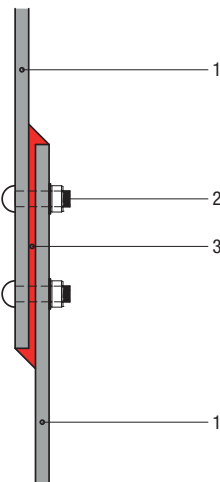

OTHER TYPICAL PROBLEMS AND SIKA SOLUTIONS:

- Steel plate joint:
Sikaflex® TS Plus
- External weathering protection:
Concrete structures:
Sikagard®-740 W, Sikagard®-675 W ElastoColor
Brick structures:
Sikagard®-703 W



SIKA SOLUTIONS FOR DIGESTION TANKS

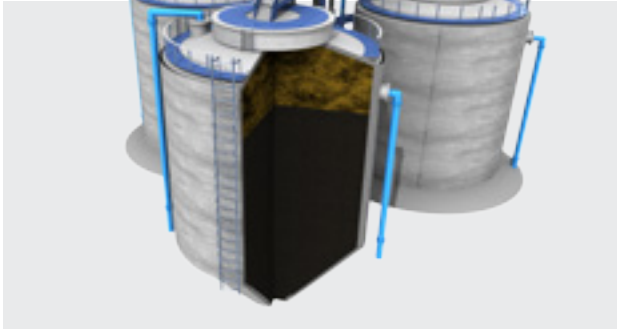

General Description & Main Requirements

The sewage sludge digestion tank is where the sludge is stabilized, reduced in volume, made innocuous through the process of dissolving organic substance with the help of anaerobic bacteria and finally, where energy is recovered.

Typical problems encountered are:

- Heavy chemical attacks above the anaerobic zones
- Leakage and risk of pollution due to cracks, untight joints or damaged concrete.

SIKA SOLUTIONS FOR HEAVY CHEMICAL PROTECTION

Concrete or steel above the sludge may suffer heavy attack due to the formation of the sulfuric acid (refer to page 16 for more details). Additional stress is caused by the elevated temperature originating from the biological process.

Down times always create problems and difficulties for the owners, as well as loss of money. Sika offers solvent free, high build coating systems which can be applied in one layer on a good prepared surface. Therefore, down times can be minimized without the reduction of the protective properties.

Sikalastic®-844 XT on primer

Sikafloor®-156/-161 on concrete or **SikaCor® EG-1** on steel

- Hot spray Polyurea
- Solvent free
- Crack bridging
- Highest chemical resistance
- 1 layer application

Sika Permacor®-3326 EG H

- High performance epoxy resin
- Solvent based
- 3 layer application





TYPICAL DETAIL

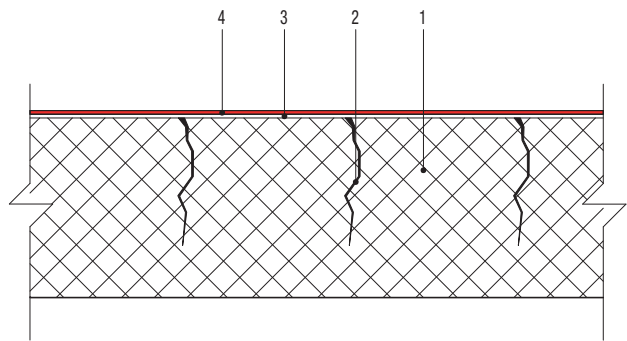

- 1 Concrete
- 2 Cracks
- 3 Primer Sikafloor®-156/-161 lightly broadcasted with quartz sand 0.3 - 0.8 mm
- 4 1 x Sikalastic®-844 XT

OTHER TYPICAL PROBLEMS AND SIKA SOLUTIONS:

- Cracks, untight joints:
Sikadur-Combiflex® SG, Sikaflex® Pro-3, Sikaflex® TS Plus
- Damaged concrete and steel reinforcement corrosion:
Sika MonoTop®-412 NFG, SikaTop® Armatec®-110 EpoCem®
- External concrete protection:
Sikagard®-740 W hydrophobic impregnation,
Sikagard®-675 W ElastoColor protective coating



SIKA SOLUTIONS FOR SECONDARY SEDIMENTATION TANKS

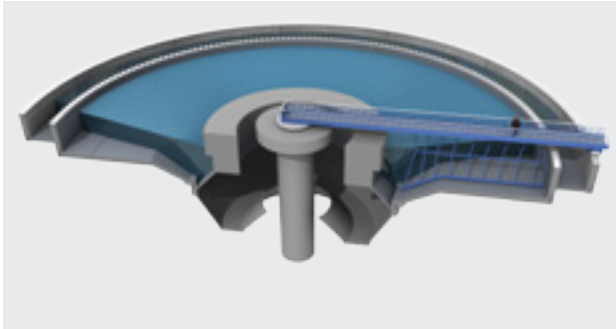

GENERAL DESCRIPTION & MAIN REQUIREMENTS

Secondary treatment is intended to degrade further the organic content of sewage water originating from human waste, soap, detergent, etc. Most of the plants treat the sewage using aerobic biological processes.

Typical problems encountered are:

- Erosion due to water flow
- Chemical attacks, depending on the aggressiveness of the waste water
- Leakage and risk of pollution due to cracks, untight joints or damaged concrete
- Steel reinforcement corrosion due to reduced concrete cover

SIKA SOLUTIONS FOR DURABLE JOINT SEALANTS

Sealants used in sewage treatment plants have to survive extremely harsh conditions and thus must meet very demanding requirements.

Sikaflex® Pro-3

- 1-component non-sag sealant
- High resistance against waste water and waste water treatment chemicals
- Excellent adhesion under permanent water immersion
- Resistance against microbiological attack
- Resistance against continuous high water pressure

Approvals & standards

- ISO 11600 25 HM, EN 15651, part 4 25 HM CC
- CSM: Very good resistance against mould and bacteria growth according to IPA (ISO 846)
- Waste water resistance according to the DIBt guidelines (German approval body for construction products and types of construction)





TYPICAL DETAIL

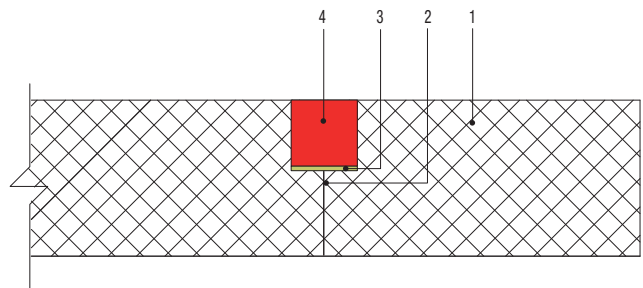

- 1 Substrate
- 2 Construction joint
- 3 Bond breaking
- 4 Sikaflex® Pro-3

OTHER TYPICAL PROBLEMS AND SIKA SOLUTIONS:

- Chemical attacks and improper waterproofing:
Sikagard®-720 EpoCem® and Sika® Poxitar F
- Cracks, untight joints:
Sikadur-Combiflex®, Sikaflex® Pro-3,
Sikaflex® TS Plus for Steel
- Damaged concrete and steel reinforcement corrosion:
Sika MonoTop®-412 NFG
SikaTop® Armatec®-110 EpoCem®



SIKA SOLUTIONS FOR FILTRATION BEDS

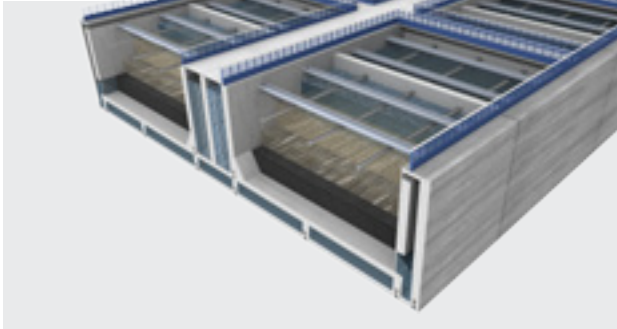

General Description & Main Requirements

In the filtration bed, the treated water flows through various layers of sand beds for final filtration before being discharged in the environment.

Filters are periodically cleaned using air and clean water at counter stream. The cleansing water is then pumped back to the aeration basin for retreatment.

Typical problems encountered are:

- Abrasion
- Damaged waterproofing
- Leakage and risk of pollution due to cracks and untight joints

SIKA SOLUTIONS FOR BLISTERING

Typical problems occurring in sewage treatment plants are the formation of blisters (see picture on page 37) when semi-permeable coatings are applied in water saturated concrete.

This can be avoided using a layer of 3 mm of Sikagard®-720 EpoCem® during the repair works.

This specially developed product acts as temporary moisture barrier allowing the application of a coating or flooring to a green or damp concrete. The advantage for the owner is reduced completion time and eliminated risk of blistering.

Other characteristics of Sikagard®-720 EpoCem® are:

- Internal curing – no curing required
- Quick over-coating with resin coatings – either water or solvent based
- Increased chemical resistance (compared to polymer modified cement based product)





TYPICAL DETAIL

- 1 Concrete substrate
- 2 Sikagard®-720 EpoCem®
- 3 Construction joint Sika® Waterbar
- 4 Sika MonoTop®-412 N

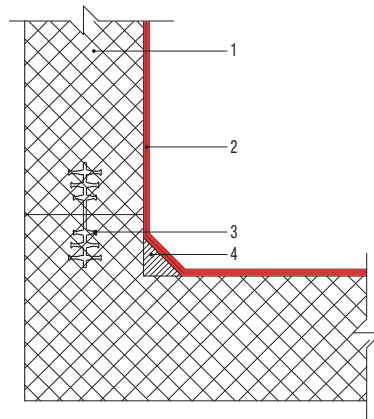

OTHER TYPICAL PROBLEMS AND SIKA SOLUTIONS:

- Damaged waterproofing:
Sikagard®-720 EpoCem®
- Abrasion:
Sika® Abraroc® SR
- Cracks, untight joints:
Sikadur-Combiflex® SG, Sikaflex® Pro-3

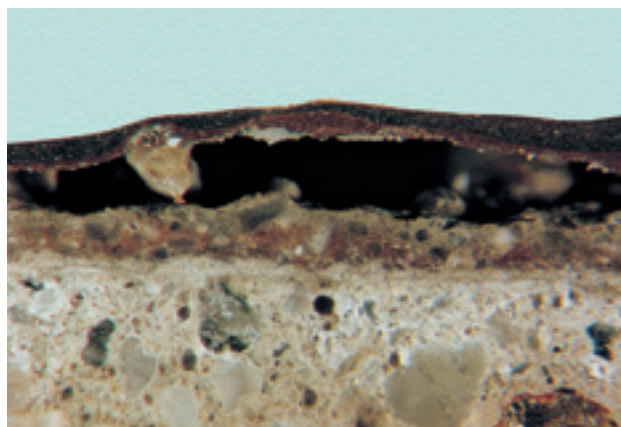

SIKA SOLUTIONS FOR TECHNICAL SERVICE BUILDINGS AND WEATHERING PROTECTION

GENERAL DESCRIPTION & MAIN REQUIREMENTS

Most waste water treatment plants have a technical service building. External surfaces of the building as well as of the above ground tanks are exposed to weathering and therefore often need protection.

In these technical buildings, chemicals are handled. Therefore, the floors in the chemical storage area also need protection.

SIKA SOLUTION FOR FLOORS

- Epoxy flooring, self levelling, solvent free, high chemical resistance:
Sikafloor®- 381
- PU-modified cementitious flooring, solvent free, excellent chemical resistance, lightly slip resistant:
Sikafloor®-21 PurCem

SIKA SOLUTIONS FOR EXTERNAL SURFACE PROTECTION

- Surface applied corrosion inhibitor:
Sika® FerroGard®-903 Plus
- Thixotropic hydrophobic impregnation for concrete:
Sikagard®-706 Thixo
- Hydrophobic impregnation for concrete:
Sikagard®-740 W
- Hydrophobic impregnation for bricks and other mineral substrates:
Sikagard®-703 W
- Concrete protective coating:
Sikagard®-675 W ElastoColor
- Crack bridging concrete protective coating:
Sikagard®-550 W Elastic





TYPICAL DETAIL

Sikafloor® coating
 Connection on drainage channel or outlet

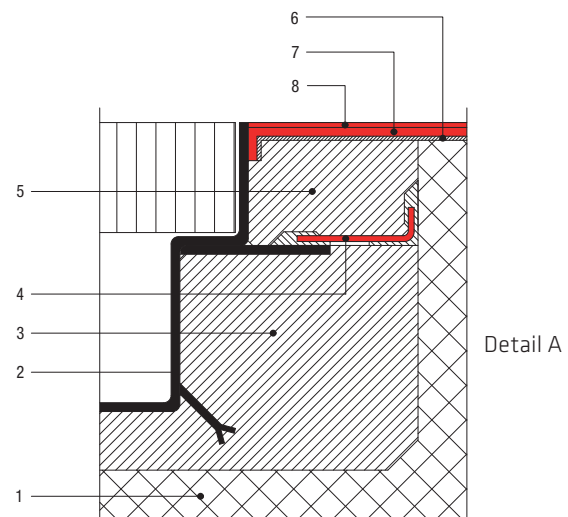
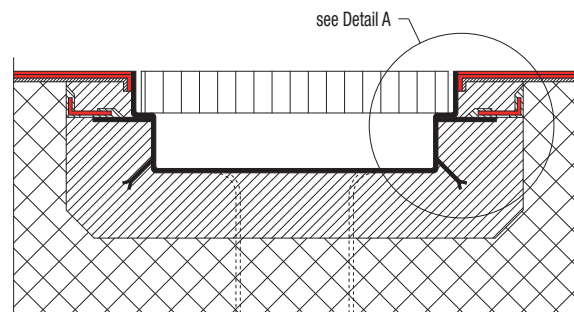

- 1 Concrete slab
- 2 Drainage channel or outlet with adhesive steel flange
- 3 SikaGrout® anchorage mortar
- 4 Sealing adhesive steel flange with Sikadur-Combiflex® SG System
- 5 SikaGrout® anchorage mortar
- 6 Sikafloor® primer (epoxy) thickness ca. 0.1 mm
- 7 Sikafloor® coating in epoxy or PUR thickness ca. 2.0 - 4.0 mm
- 8 Sikafloor® finishing thickness ca. 0.1 - 0.4 mm according to the selected coating system and the mechanical load anticipated in service



OTHER TYPICAL PROBLEMS AND SIKA SOLUTIONS:

Roofs in the buildings (technical and office) of the sewage treatment plants may require waterproofing. Sika offers full range of roof waterproofing that fits the different needs of owner:

- SikaPlan® PVC or FPO membrane
- Sikalastic® liquid applied membrane

SIKA SOLUTIONS FOR NEW CONSTRUCTIONS

CONCRETE FOR SEWAGE AND WASTE WATER TREATMENT PLANTS

Reinforced concrete forms the load-bearing framework, floors and walls for practically all of the specialist structures in sewage and waste water treatment plants. These include all of the drainage channels and pipework into the plant and between the different processes including initial mechanical screening and separation, primary sedimentation tanks, secondary treatment including clarification in aeration / biological digestion tanks, and finally any tertiary specialist chemical treatments and purification that are required.

High performance durable concretes must be used for these structures, particularly for direct contact with the sewage and waste water. However, it should be clearly understood that concrete alone cannot withstand all of the different types and degrees of mechanical and chemical attack that can be imposed in a waste water treatment plant. The correct design and construction of these structures, together with the additional surface protection systems required, are therefore all essential for long-term durability. Timely scheduled and correct maintenance are essential.

The main technical challenge for concrete is to resist in this harsh physical and chemical environment.

Concrete Corrosion & Erosion:

- Mechanical abrasion & erosion
- Freeze-thaw attack, with or without de-icing salts
- Chemical attack (acid and sulfate attack)
- Alkali-aggregate reaction (ASR)

Depending on the degree of exposure, the concrete can be designed and placed to provide increased levels of resistance, or this level can be further increased by the application of a suitable protective surface treatment. The so-called 'tidal zones' of tanks and structures which are areas continuously alternating between dry and wet exposure due to variations in water levels, are particularly at risk. In these zones, the damage processes can be accelerated by the alternating high oxygen and high water / chemical exposure. Over time, in some structures an organic "protective barrier layer" is formed on the concrete surfaces; however, each time this layer is removed by the cleaning scrapers, the concrete surface can also be abraded and is gradually eroded. The operation of the plant must therefore be optimized to minimize damage from this process.

Where the concrete surfaces are to be exposed, it is always important to pour and place the concrete as dense as possible, with minimal voids or surface cracking, plus:

- High ASR resistance is achieved through modifying the cement binder by adding suitable quantities of pulverized fly ash (PFA), or ground-granulated-blast-furnace-slag (GGBFS).
- Increased resistance to freeze-thaw action is obtained by adding air entraining agents.



- High resistance to mechanical impact and abrasion is achieved using a low water/cement ratio and added silica fume.

Chemical resistance is related to the impermeability and density of the surface and the cement matrix, so a low w/c ratio and closed finish is necessary. However, against aggressive chemicals, particularly strong acid attack, the resistance of concrete alone is limited. Therefore, an additional protective surface treatment must be applied.



TYPICAL DETAIL

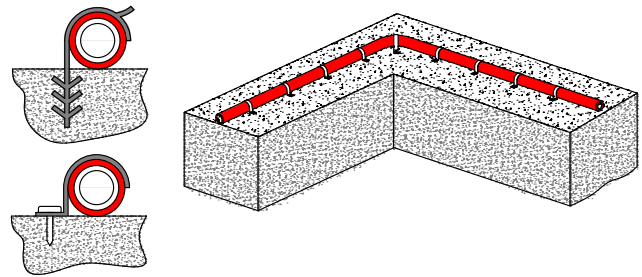

No matter how good a concrete is, the failure will occur at points of weakness: construction joints, cold joints and expansion joints, pipe penetrations, fixing, etc.

Since decades, Sika provides a wide range of solutions to cater for all types of detailing: Sika® Waterbar for construction and expansion joints; Sikaflex® Pro-3, a chemical resistant joint sealant; SikaFuko® Hose, re-injectable hoses for construction joints; Sikadur-Combiflex® SG System, for sealing construction joints, failed sealants, cracks etc.

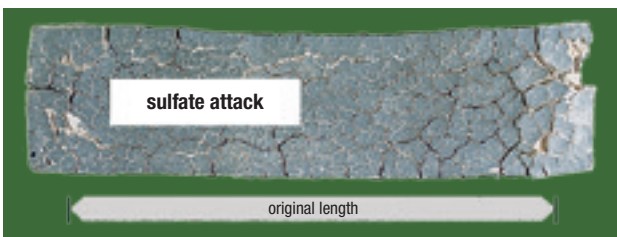

Sulfate driven attack is primarily caused by sulfates dissolved in water. By reacting with the hardened cement matrix, an increase in volume is induced, which damages the structure. (Picture: BetonSuisse, Merkblatt 01)



Acidic attacks which dissolve calcium compounds out of the hardened cement matrix can be caused by acids, exchangeable salts, vegetable and animal fats or oils. Degradation of the concrete usually occurs very slowly. (Picture: BetonSuisse, Merkblatt 01)

MORE SIKA SOLUTIONS

GENERAL DESCRIPTION & MAIN REQUIREMENTS

Additionally to the different problems exposed in the previous pages, sometimes special issues are raised such as strengthening of a basin, anchoring some ladders in a tank, making an opening for a new pipe, waterproofing the flat roof of a new building, etc. Sika provides fully compatible products and integrated systems to suit almost every refurbishment project and site requirement.

SIKA SOLUTIONS FOR STRUCTURAL STRENGTHENING

Due to design errors, upgrading of a structure or damage of the concrete substrate, structural strengthening may be necessary. Bonding of strengthening products to an existing structure can extend its lifetime significantly avoiding demolition and rebuilding. Structural strengthening by bonding of external plates or lamination of fabrics is carried out in accordance with relevant design codes.

The surfaces where the externally bonded reinforcement will be installed must be prepared and cleaned thoroughly. Any damages or deteriorated concrete must be removed and repaired to comply with EN 1504 part 10 section 7.2.4 and section 8. Depending on the project, different solutions are available:

Sika CarboDur® plates

- Pre-cured CFRP plates
- Bonded with Sikadur®-30 adhesive
- Light weight and easy to install, especially overhead
- Very high strength
- Excellent durability and fatigue resistance
- Minimal preparation, applicable in several layers
- Can alternatively be embedded into the substrate

SikaWrap® Fabrics

Dry fibre fabrics, saturated on site

Laminated with Sikadur®-330 or Sikadur®-300 resin

- Available in different weights and widths
- Flexible and accommodating of different surface planes and geometry
- Multifunctional material for use in different strengthening applications

Sika CarboStress® System

- Unique pre-stressed strengthening system
- Advantages of Sika CarboDur® CFRP plates
- Advantages of post tensioning
- StressHead anchorage system

Others:

CarboShear L: Profiles for shear strengthening of beams

CarboHeater: Accelerated curing of Sikadur®-30 adhesive



SIKA SOLUTIONS FOR GROUTING

SikaGrout®-314

- High performance shrinkage compensated cementitious grout
- CE marked as EN 1504-6, anchoring of reinforcement bars
- Low shrinkage, high mechanical strength
- Grouting under base plates, machine bases etc.
- Fast strength development

SIKA SOLUTIONS FOR ANCHORING

Sika® AnchorFix-1

- Solvent- and styrene free two part polyester anchoring adhesive
- ETA 029 approvals for injection systems for use in hollow masonry
- ETA 001 - 1 & 5 approvals for injection systems for the use in concrete



TYPICAL DETAIL

- 1 Concrete substrate
- 2 Sika® AnchorFix-1, 2 or 3
- 3 Leveling mortar Sikadur®-41

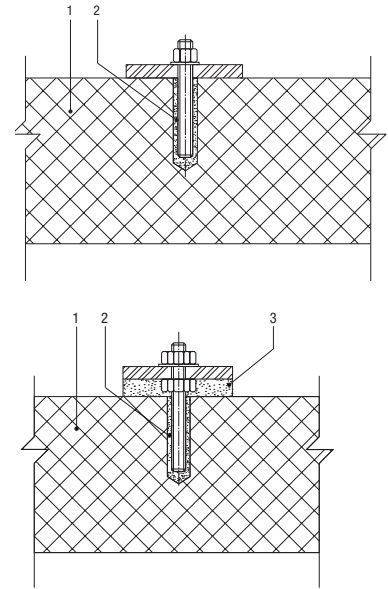

Sika® AnchorFix-2

- Solvent- and styrene free, epoxy acrylate based, two part anchoring adhesive
- ETA 001 approvals for threaded rods
- ETA 001 TR023 approval for rebars
- Fire approval for threaded and reinforcement bars

Sika® AnchorFix-3+

- Solvent-free, thixotropic, two part, epoxy resin-based, high performance anchoring adhesive
- ETA 001 approvals for anchors in concrete
- Outstanding chemical resistance to sulfuric acid, ammonia and sodium hydroxide solution



CASE STUDIES

SEWAGE TREATMENT PLANTS AL WATHBA AND AL SAAD, ABU DHABI



PROJECT DESCRIPTION

The ADWEA sewage project consists of two newly built sewage treatment plants in Abu Dhabi (Al Wathba and Al Saad plant). These two main sewage plants receive approx. 95% of the sewage from Abu Dhabi and Al Ain. The sewage is delivered from substations all around the area.

PROJECT REQUIREMENTS

Main requirements are the chemical resistance to sewage, crack bridging properties, mechanical resistance, waterproofing, suitable floorings, also electrically conductive floors and long lasting joint sealing materials. 36 Sika products have been approved for use in the project.

SIKA SOLUTION

The anaerobic digester tanks have been internally lined with Sikalastic®-844 XT.

Pump stations and settlement tanks have been protected with a glass fibre reinforced system Sikagard®-63 N.

The protection in the aeration and effluent tanks has been executed with SikaTop® Seal-107, reinforced with a glass fabric. Floors in the substations and the workshops have been protected with Sikafloor®-264 and Sikafloor®-325 on primer Sikafloor®-161.

The floor of the electric rooms was protected with Sikafloor®-262 AS.

İSKI İKİTELLİ WASTE WATER TREATMENT PLANT, ISTANBUL, TURKEY



PROJECT DESCRIPTION

This is a large sewage water treatment plant with capacity to provide water to 5'200'000 people, 40% of the population in Istanbul. It has 2 separate water treatment systems, which provide 840.000 m³ of clean water a day. System 1 was completed in 1998 and system 2 in 2003.

PROJECT REQUIREMENTS

The sewage treatment plant treats waste water containing the biological contamination and eutrophication. It needs to use various procedures and chemicals to make the water finally clean before going back to the city's water supply system. The water containing structures have to survive under extremely severe conditions and resist against microbiological and chemical attack.

SIKA SOLUTION

Concrete spallings were repaired using Sika MonoTop® polymer modified patch repair mortar.

Concrete was protected against chemical aggression with first a primary application of Sikagard®-720 EpoCem as temporary moisture barrier, followed by Sikagard®-2040 TR chemical resistant epoxy coating.

Jointing of concrete elements was done with the chemical resistant sealant Sikaflex® Pro 3.

WROCŁAW WASTE WATER TREATMENT PLANT, POLAND



PROJECT DESCRIPTION

The sewage treatment plant in Wrocław is a mechanical-biological sewage treatment plant with chemical-assisted removal of phosphorus and full sludge processing. The goal of the third phase of development and modernization of the sewage treatment plant was to increase the capacity from an average of 70 000 to 140 000 m³ per day, and to fulfill more stringent standards of water leaving the plant and entering the river stream.

PROJECT REQUIREMENTS

Settlement tanks and sludge pump stations needed to be rehabilitated. New structures needed to be built like grit chambers, primary and secondary settlement tanks, digestion chambers, sludge dehydration buildings and biomass tanks.

SIKA SOLUTION

Sika could provide a technical solution for the following applications:

Preliminary and secondary settlement tank walls:

Sika® Repair-30 F – repair mortar and Sika® Poxitar F – epoxy coating (3 layers)

Preliminary and secondary settlement tank floor:

Sikafloor® 156 – epoxy levelling mortar and Sika® Poxitar F – epoxy coating (3 layers)

Top of tanks and driving range:

Sika® Elastomastic TF – 3 mm highly mechanical and chemical resistant epoxy polyurethane hybrid and Sikaflex® PRO 3 – chemical resistant polyurethane sealant

Pumping Station:

Sika® Repair-30 F – as levelling mortar and Sika® Poxitar F – epoxy coating (3 layers)

Digestion chambers:

Sika® Repair-30 F – as levelling mortar and Sika® Poxitar F – epoxy coating (3 layers – laminated)

SINDELFINGEN-BÖBLINGEN WASTE WATER TREATMENT PLANT, GERMANY



PROJECT DESCRIPTION

This plant belongs to the community towns of Sindelfingen and Böblingen. This WWTP alone treats over 15 million cubic meter of waste water annually. The plant boasts efficient treatment of the waste water. For organic pollutants a purification rate of over 90% is achieved and at the same time more than 70% of dissolved nutrients including phosphorus and nitrates are removed from the water.

PROJECT REQUIREMENTS

The two primary settlement tanks and the mechanical scrapper tracks were in need of immediate refurbishment. Concrete under the settlement tanks was suffering from decays. The mechanical scrapper tracks were subjected to heavy abrasion. Exposed steel structures were corroding.

SIKA SOLUTION

Sika could provide a technical solution for each application:

Settlement tanks:

Concrete repair:

Sika MonoTop®-601 Neu – exposed steel protection
Sika MonoTop®-602 / 603 Neu – Polymer modifier repair mortar
Sika® Icoment®-520 – Resurfacing mortar
Sika® Poxitar® F – Chemical protection

Scrapper track refurbishment:

Sikafloor®-156 – Epoxy primer
Sika® Elastomastic® TF – wear resistant, crack bridging polyurethane epoxy resin
Sikafloor®-359 – abrasion resistance polyurethane sealer coat

Steel work:

SikaCor®-EG System – primer, epoxy intermediate coat and polyurethane top coat

ALSO AVAILABLE FROM SIKA

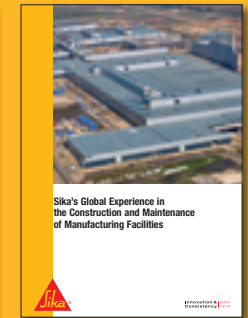
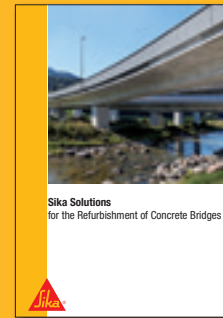
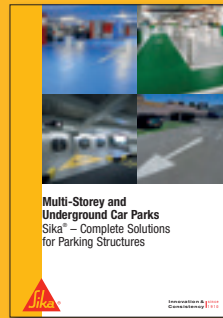
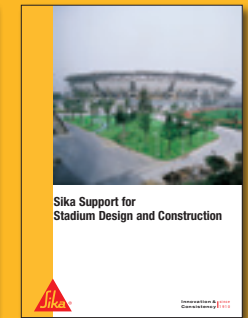
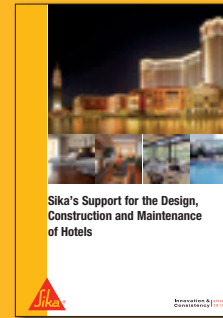
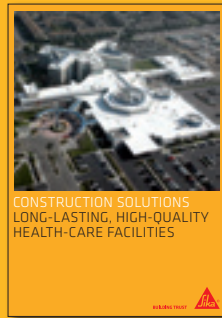
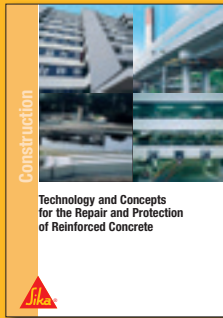
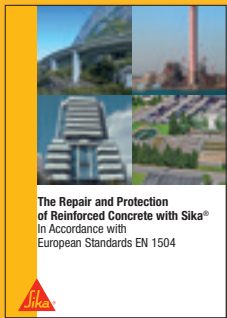

FOR MORE REFURBISHMENT SOLUTIONS:



www.sika.gr

WE ARE SIKA

Sika is a specialty chemicals company with a leading position in the development and production of systems and products for bonding, sealing, damping, reinforcing and protecting in the building sector and the motor vehicle industry. Sika's product lines feature concrete admixtures, mortars, sealants and adhesives, structural strengthening systems, flooring as well as roofing and waterproofing systems.

Our most current General Sales Conditions shall apply.
Please consult the Data Sheet prior to any use and processing.

© SIKA HELLAS ABEE / REFURBISHMENT / SIKA TECHNOLOGIES AND SOLUTIONS FOR
WASTE WATER TREATMENT PLANT / 05.2016 / HE#00202

Sika Hellas ABEE
15 Protomagias str.
GR 145 68, Kryoneri,
Attica, Greece

Contact
Tel. + 30 210 81 60 600
Fax + 30 210 81 60 606
Mail: sika@gr.sika.com

BUILDING TRUST

